

ZMR

Zammit Metal Roofing



*Bateau Bay
Rapid Seam / Dover White
Built by GBM Building*

Product Brochure



Contents

Roofing Series	3
- R SERIES: Rapid Corrie	4
- R SERIES: Rapid Deck	5
- Custom Flashing	6
- Colorbond Colour Range	7
- Roof Battens	8
- Commercial Products	9
- Gutter Protection	17
Architectural Products	24
- R SERIES: Rapid Seam	25
- R SERIES: Rapid Clad	26
- Aluminium Battens	27
- Aluminium Cladding	31
- Aluminium Decking	33
Custom Trade Work	35
Skylights	36
Rain Water Goods	42
ZMR Pergola Range	51
- Louvered Roof Pergola	52
- Insulated Roof Pergola	53
- Exposed Rafter Roof Pergola	54
- ZMR Aluminium	55
- ZMR Steel	57
- ZMR Fascia Gutters	59
- ZMR Beams & Posts	60
- Insulated Roofing Panels	61
- Polycarb / Fibreglass	62
Accessories	66

WELCOME

For over 35 years, Zammit Metal Roofing has been a foundation of the Sydney's metal roofing industry. Our unwavering dedication to quality manufacturing and exceptional service has made us a trusted name among roofers, architects, and tradespeople throughout New South Wales.

Specializing in the manufacturing and supply of metal roofing products, we pride ourselves on being at the forefront of innovation. Continuously improving and adapting to meet the evolving needs of the market.

Renowned for our premium materials, and extensive industry expertise, Zammit Metal Roofing stands as a preferred choice for metal roofing manufacturers in Sydney. Whether it's for residential or commercial projects, our commitment to customer satisfaction remains unwavering.

Conveniently located in Glendenning, our reach extends far beyond our physical location. With a solid reputation as the leading metal roofing manufacturer in Sydney and across New South Wales, we are the go to supplier and manufacturer of all your metal roofing needs.



ZMR ROOFING

ZMR R Series

Discover the perfect fusion of timeless elegance and modern sophistication with Zammit Metal Roofing's R-Series. Offering a harmonious blend of classic roof profiles and cutting edge architectural roof and wall cladding designs, the R-Series is the epitome of style and functionality. With a comprehensive selection available in the full Colorbond range, you can elevate your project with enduring beauty and superior performance. Experience the pinnacle of design & quality with Zammit Metal Roofing's R-Series.



Rapid Corrie is an extremely popular corrugated profile, equally beneficial & stylish for both contemporary & classic style homes. It is available up to 22m lengths making it perfect for both roofing & wall cladding. Rapid Corrie is available in a range of colours and can be reversed rolled to have colour underneath.

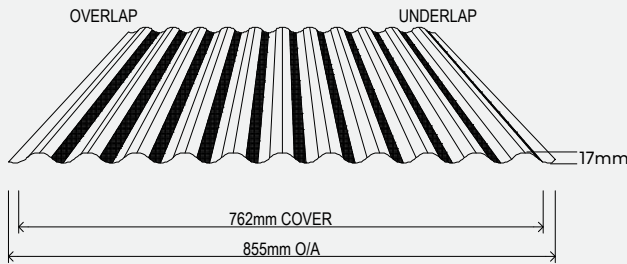

BMT	ROOF SPAN (INT/END)*	MIN PITCH
0.42	1200/900	5°
0.48	1700/1300	5°

- Pricing per lineal metre
- 762mm Coverage
- 5° Minimum Pitch
- Custom Cut Lengths

LENGTH (in mm)
MIN: 500mm
MAX: 20 000mm

Apron Standard

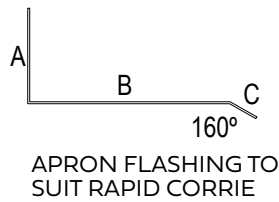
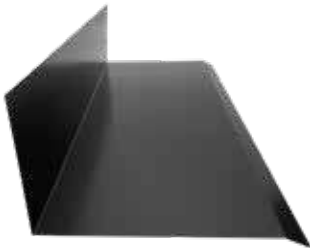

Apron Standard with Pressure Seal

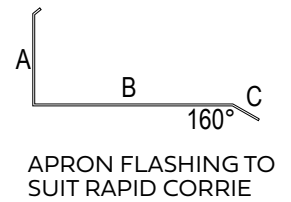

Barge Standard

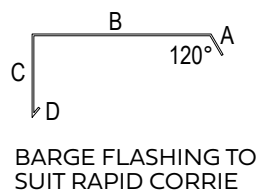

Pitch Flashing Corrie

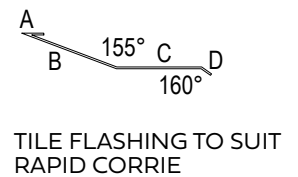

Ridge Cap

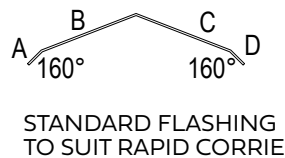

Roll Top Corrie

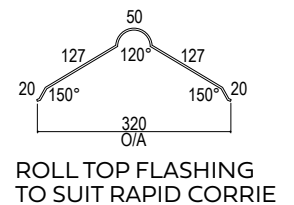

Rapid Corrie Accessories



50MM ROOF ZIP



INFILL STRIP



Rapid Deck features a high rib profile with fluted pans, it is available up to 22m lengths making it perfect for both roofing & wall cladding. Rapid Deck is available in a range of colours and can be reversed rolled to have colour underneath.

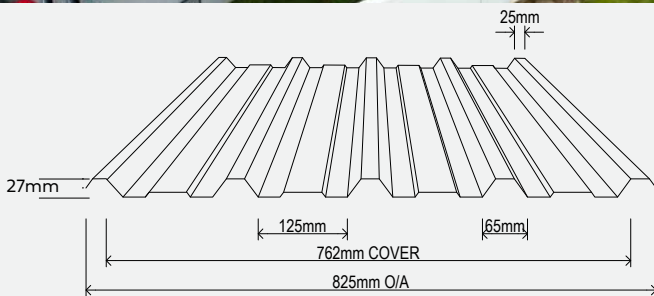

BMT	ROOF SPAN (INT/END)*	MIN PITCH
0.42	1900/1300	2°
0.48	2600/1850	2°

- 762mm Coverage
- 2° Minimum Pitch
- Custom Cut Lengths

LENGTH (in mm)
MIN: 500mm
MAX: 20 000mm

Apron Standard



APRON FLASHING TO SUIT RAPID DECK

Pitch Flashing

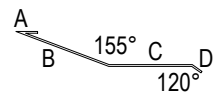

TILE FLASHING TO SUIT RAPID DECK

Ridge Cap

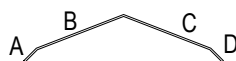

RIDGE FLASHING TO SUIT RAPID DECK

Barge Flashing

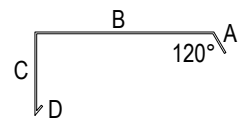

BARGE FLASHING TO SUIT RAPID DECK

Standard Valley

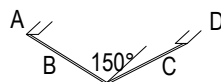

STANDARD VALLEY TO SUIT RAPID DECK

Rapid Deck Accessories



65mm ROOF ZIP



INFILL STRIPS TOP

INFILL STRIPS BOTTOM



Gutters

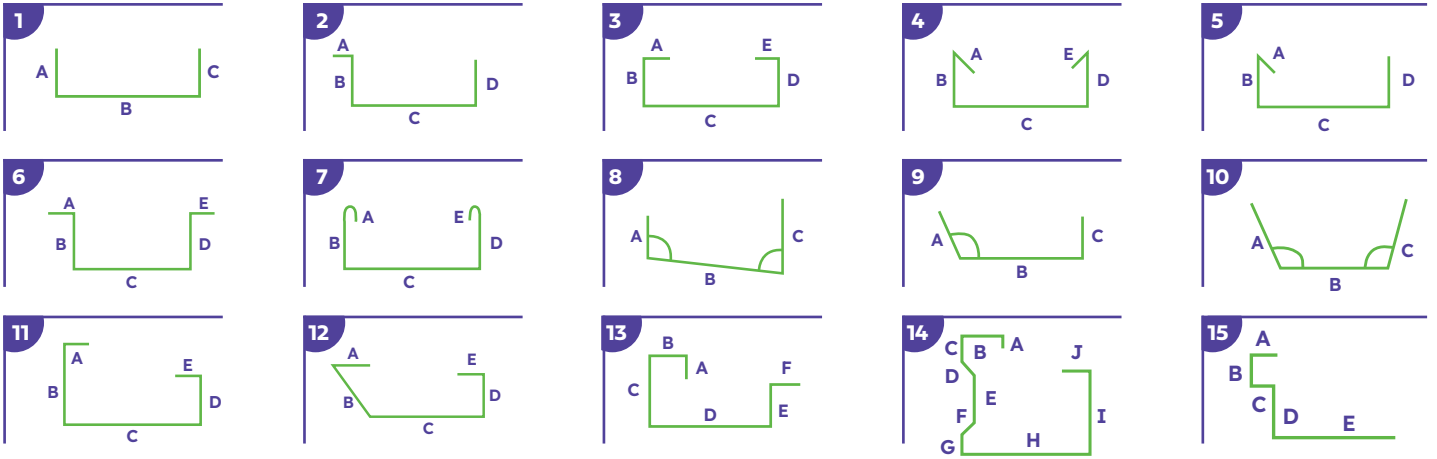

Cappings

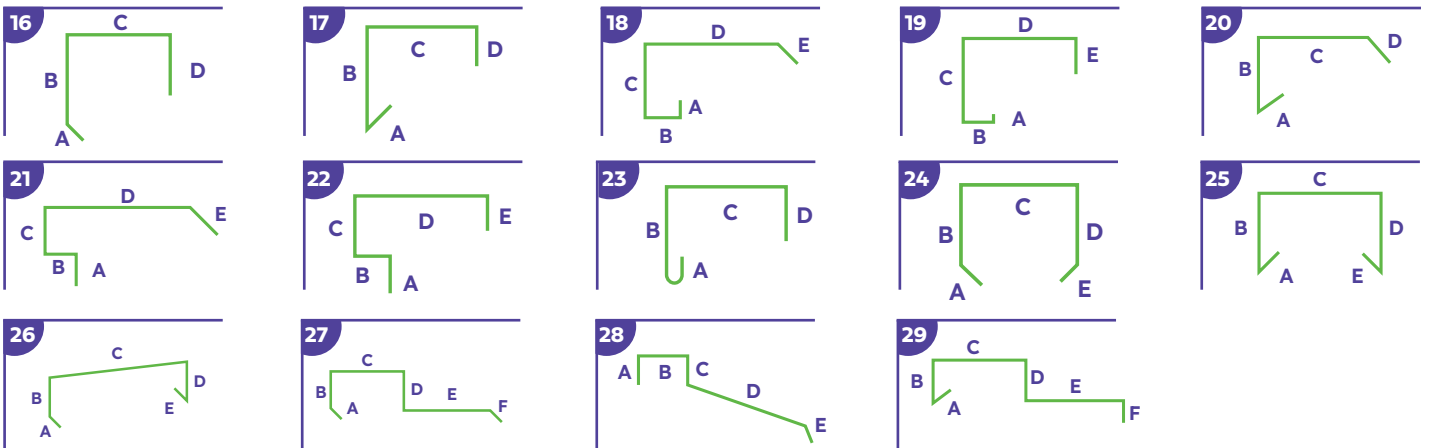

Common Flashings and Aprons

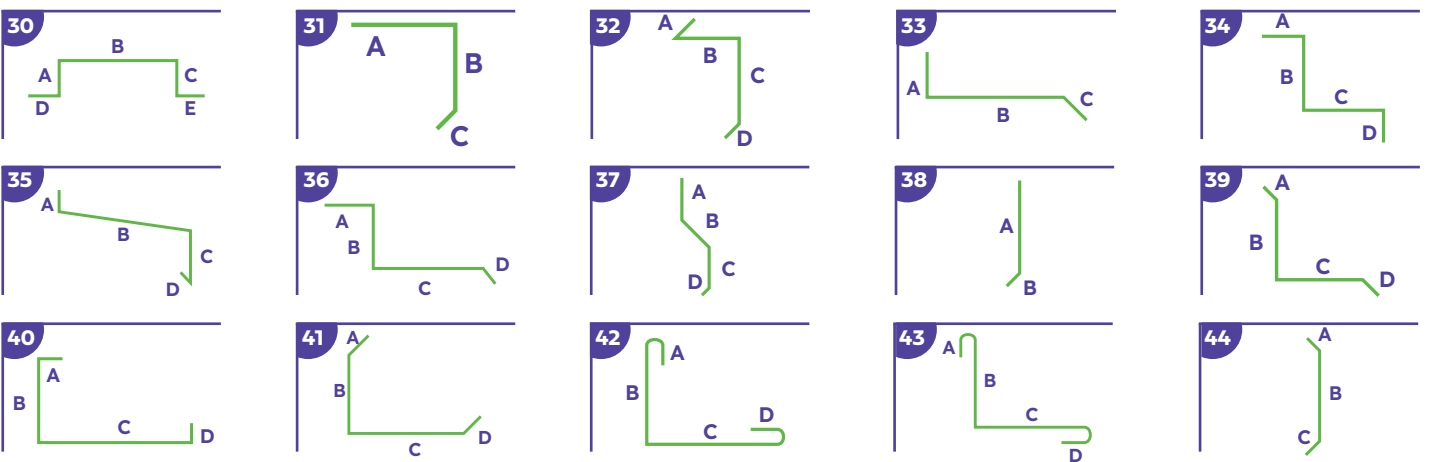

Others

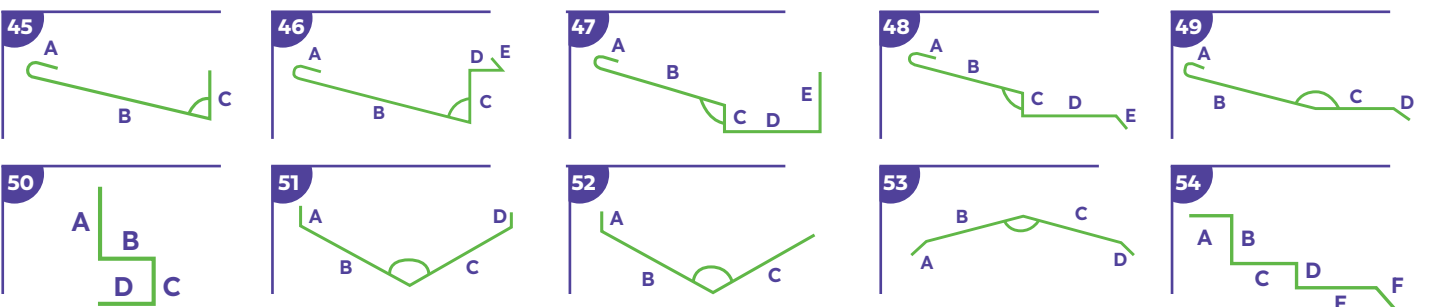

CLASSIC



MATT

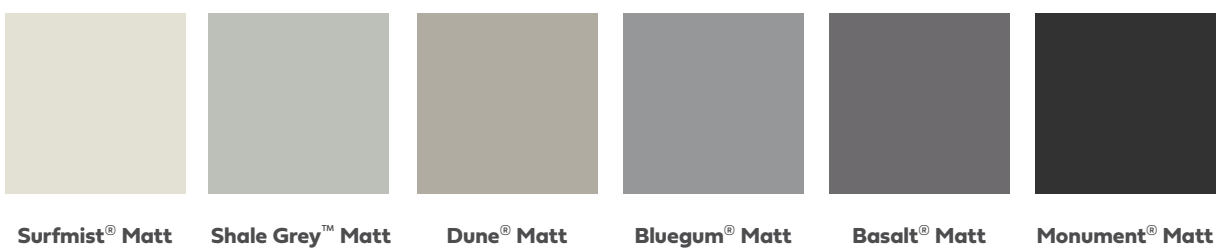

ULTRA

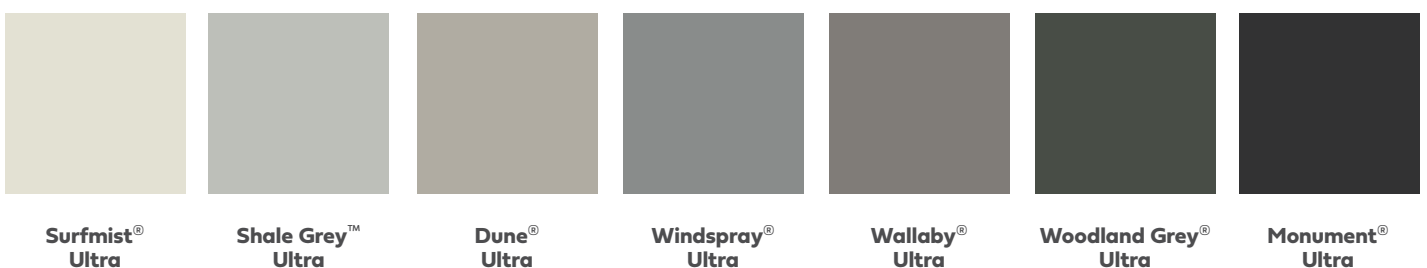



Ceiling battens and roof battens can be used in a wide array of residential, commercial, and industrial applications. These products are designed to function as a secondary member to support roof or wall cladding.

Product features and benefits:

- Extensive range of building applications
- Big spans allow for diverse installations
- Wide range of product gauges
- Simple and effective screw fasteners
- Fast and easy to install
- Available as galvanised steel and Zinalume
- Largest range of products available
- Rolled safety edges are standard

Note: Standard Roof Battens are Angle Cut. Square Cut ends available by request.

22mm Ceiling Batten 0.42

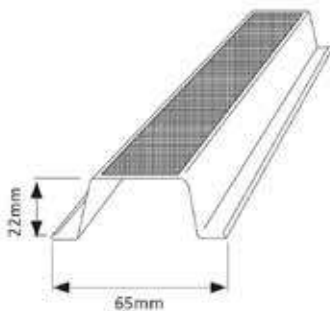

22 mm CEILING BATTEN – 0.42 BMT – ALUZINC: **22CB0.42Z** (0.36kg/m)

22mm Ceiling Batten 0.75

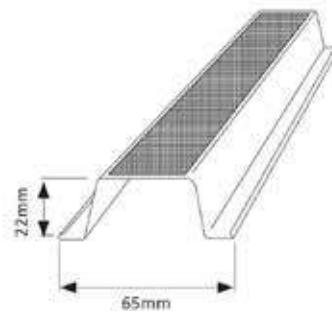

22 mm CEILING BATTEN – 0.75 BMT – ALUZINC: **22CB0.75Z** (0.63kg/m)

40mm Cyclonic Roof Batten 0.75

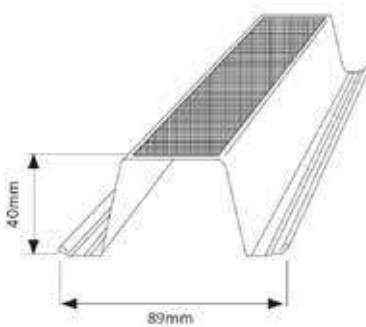

40 mm ROOF BATTEN – 0.75 BMT – ALUZINC: **40RB0.75Z** (1.02kg/m)

NOTE*: Standard Roof Battens are ANGLE CUT, SQUARE CUT ends would need to be requested.

40mm Roof Batten 0.48

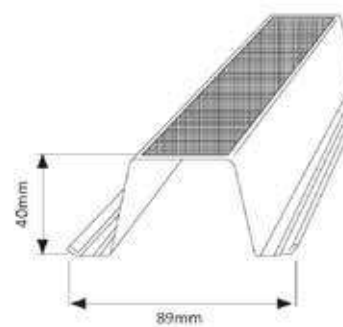

40 mm ROOF BATTEN – 0.48 BMT – ALUZINC: **40RB0.48Z** (0.66kg/m)

NOTE*: Standard Roof Battens are ANGLE CUT, SQUARE CUT ends would need to be requested.

40mm Roof Batten 0.55

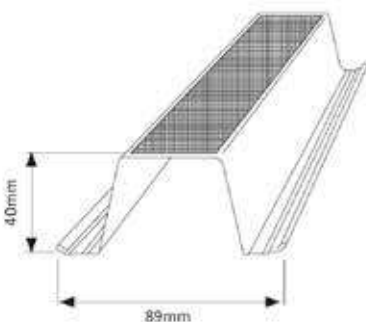

40 mm ROOF BATTEN – 0.55 BMT – ALUZINC: **40RB0.55Z** (0.75kg/m)

NOTE*: Standard Roof Battens are ANGLE CUT, SQUARE CUT ends would need to be requested.

Timber Batten





ZMR offers an extensive range of high-quality C & Z Purlins, and Top Hats that provide reliable support to roofing and wall cladding. Our products are designed to meet the needs of various industrial, commercial, construction, and civil applications.

Choose from our wide selection of C & Z Purlins, and top hats to ensure the structural integrity of your roofing systems

C - Section Archetype Purlin

Our Archetype Purlins™ are manufactured from high-quality galvanised steel. We use G450, G500, and G550 products with a minimum Z350 coating. All materials conform to AS 1397

We supply Archetype Purlins™ and to support roof and wall sheeting. Our products are used in a variety of industrial, commercial, construction, and civil applications.

Purlin C75 x 75

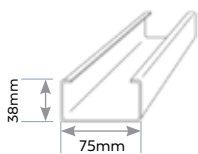

PURLIN – C75 X 0.75
BMT: **C750.75** (1.02kg/m)

Purlin C75 X 0.95

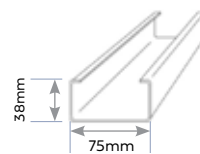

PURLIN – C75 X 0.95
BMT: **C750.95** (1.28kg/m)

Purlin C75 X 1.20

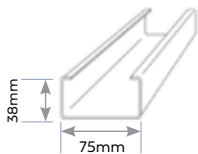

PURLIN – C75 X 1.20
BMT: **C7512** (1.61kg/m)

Purlin C75 X 1.50

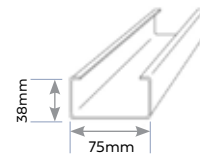

PURLIN – C75 X 1.50
BMT: **C7515** (2.00kg/m)

Purlin C100 X 1.00

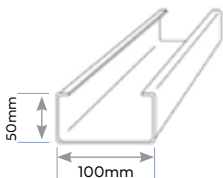

PURLIN – C100 X 1.00
BMT: **C10010** (1.64kg/m)

Purlin C100 X 1.20

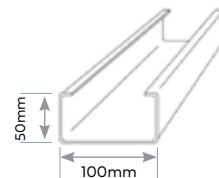

PURLIN – C100 X 1.20
BMT: **C10012** (2.06kg/m)

Purlin C100 X 1.50

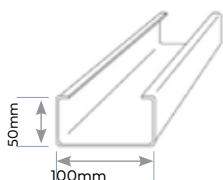

PURLIN – C100 X 1.50
BMT: **C10015** (2.57kg/m)

Purlin C100 X 1.90

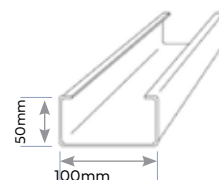

PURLIN – C100 X 1.90
BMT: **C10019** (3.24kg/m)

Purlin C150 X 1.20

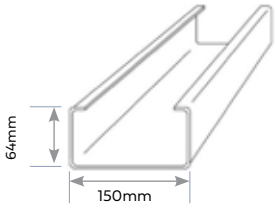

PURLIN – C150 X 1.20
BMT: **C15012** (2.83kg/m)

Purlin C150 X 1.50

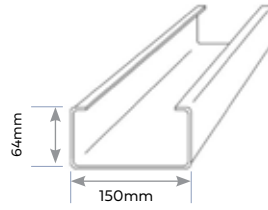

PURLIN – C150 X 1.50
BMT: **C15015** (3.52kg/m)

Purlin C150 X 1.90

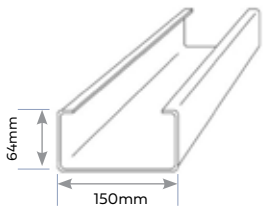

PURLIN – C150 X 1.90
BMT: **C15019** (4.45kg/m)

Purlin C150 X 2.40

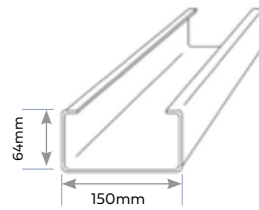

PURLIN – C150 X 2.40
BMT: **C15024** (5.60kg/m)

Purlin C200 X 1.20

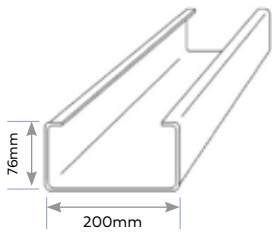

PURLIN – C200 X 1.20
BMT: **C20012** (3.59kg/m)

Purlin C200 X 1.50

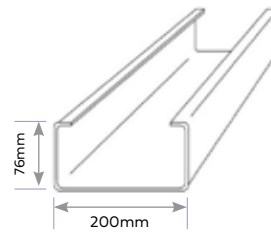

PURLIN – C200 X 1.50
BMT: **C20015** (4.47kg/m)

Purlin C200 X 1.90

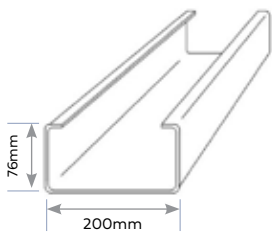

PURLIN – C200 X 1.90
BMT: **C20019** (5.65kg/m)

Purlin C200 X 2.40

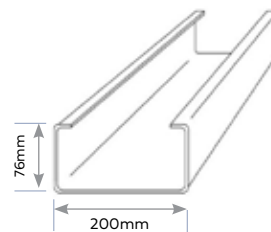

PURLIN – C200 X 2.40
BMT: **C20024** (7.12kg/m)

Purlin C250 X 1.50

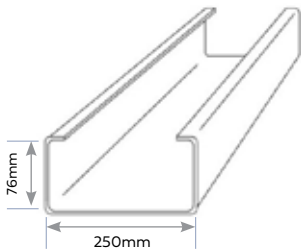

PURLIN – C250 X 1.50
BMT: **C25015** (5.07kg/m)

Purlin C250 X 1.90

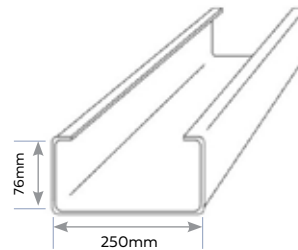

PURLIN – C250 X 1.90
BMT: **C25019** (6.41kg/m)

Purlin C250 X 2.40

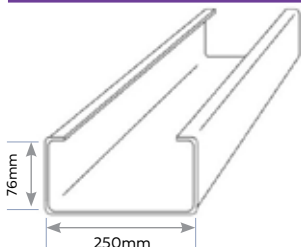

PURLIN – C250 X 2.40
BMT: **C25024** (8.07kg/m)

Purlin C300 X 1.90

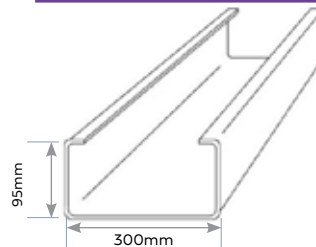

PURLIN – C300 X 1.90
BMT: **C30019** (7.91kg/m)

Purlin C300 X 2.40

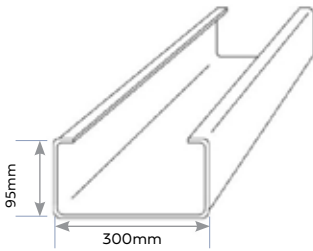

PURLIN – C300 X 2.40
BMT: **C30024** (9.97kg/m)

Purlin C300 X 3.00

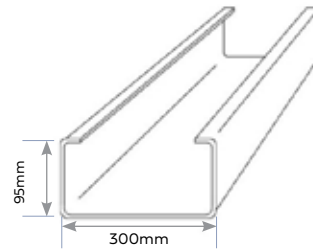

PURLIN – C300 X 3.00
BMT: **C30030** (12.51kg/m)

Z - Section Archetype Purlin

Our **Archetype Purlins™** are manufactured from high-quality galvanised steel. We use G450, G500, and G550 products with a minimum Z350 coating. All materials conform to AS 1397.

We supply **Archetype Purlins™** to support roof and wall sheeting. Our products are used in a variety of industrial, commercial, construction, and civil applications.

Z100 Purlin x 1.20

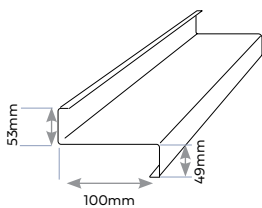

Z PURLIN – 100 X 1.20
BMT: **Z10012** (2.06kg/m)

Z100 Purlin x 1.50

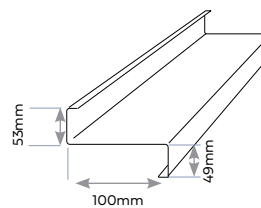

Z PURLIN – 100 X 1.50
BMT: **Z10015** (2.57kg/m)

Z100 Purlin x 1.90

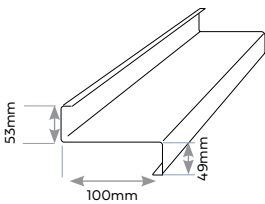

Z PURLIN – 100 X 1.90
BMT: **Z10019** (3.24kg/m)

Z Purlin 150 x 1.20

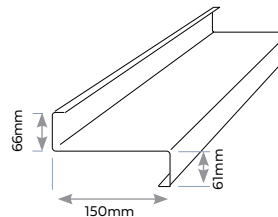

Z PURLIN – 150 X 1.20
BMT: **Z15012** (2.83kg/m)

Z Purlin 150 x 1.50

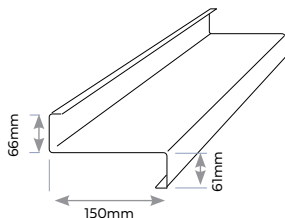

Z PURLIN – 150 X 1.50
BMT: **Z15015** (3.52kg/m)

Z Purlin 150 x 1.90

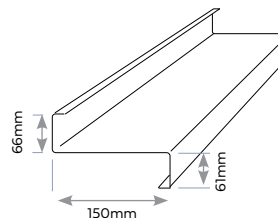

Z PURLIN – 150 X 1.50
BMT: **Z15019** (3.52kg/m)

Z Purlin 150 x 2.40

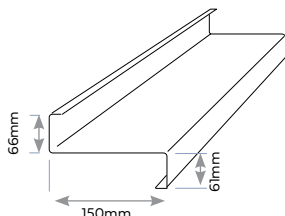

Z PURLIN – 150 X 2.40
BMT: **Z15024** (5.60kg/m)

Z Purlin 200 x 1.20

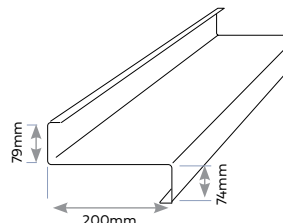

Z PURLIN – 200 X 1.20
BMT: **Z20012** (3.59kg/m)

Z Purlin 200 x 1.50

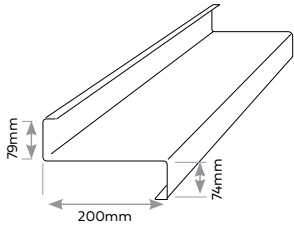

Z PURLIN – 200 X 1.50
BMT: **Z20015** (4.47kg/m)

Z Purlin 200 x 1.90

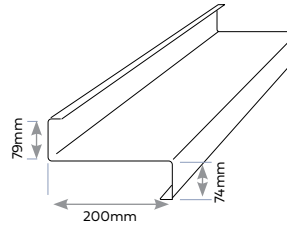

Z PURLIN – 200 X 1.90
BMT: **Z20019** (5.65kg/m)

Z Purlin 200 x 2.40

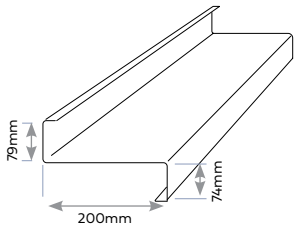

Z PURLIN – 200 X 2.40
BMT: **Z20024** (7.12kg/m)

Z Purlin 250 x 1.50

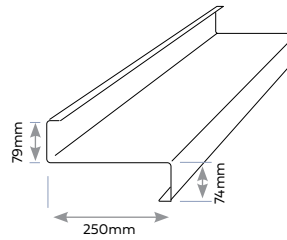

Z PURLIN – 250 X 1.50
BMT: **Z25015** (5.07kg/m)

Z Purlin 250 x 1.90

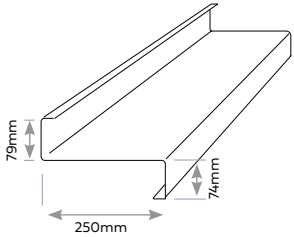

Z PURLIN – 250 X 1.90
BMT: **Z25019** (6.41kg/m)

Z Purlin 250 x 2.40

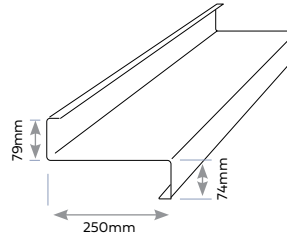

Z PURLIN – 250 X 2.40
BMT: **Z25024** (8.07kg/m)

Z Purlin 300 x 1.90

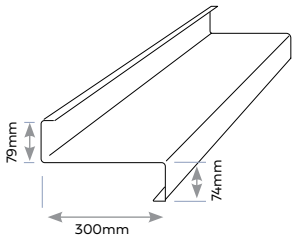

PURLIN – C75 X 0.75
BMT: **C750.75** (1.02kg/m)

Z Purlin 300 x 2.40

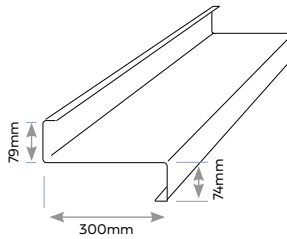

PURLIN – C75 X 0.75
BMT: **C750.75** (1.02kg/m)

Z Purlin 300 x 3.00

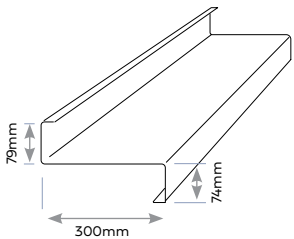

PURLIN – C75 X 0.75
BMT: **C750.75** (1.02kg/m)

Top-Hat

Top hats can be used in a wide array of residential, commercial, and industrial applications. These products are designed to function as a secondary member to support roof or wall cladding.

Product features and benefits:

- Extensive range of building applications
- Big spans allow for diverse installations
- Wide range of product gauges
- Simple and effective screw fasteners
- Fast and easy to install
- Available as galvanised steel and Zinalume
- Largest range of products available
- Rolled safety edges are standard

50mm Top-Hat 0.75

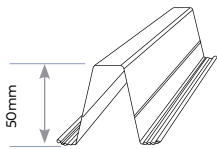

50 mm TOP HAT – 0.75
BMT: **50TH0.75** (1.09kg/m)

50mm Top-Hat 0.95

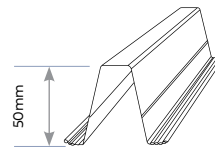

50 mm TOP HAT – 0.95
BMT: **50TH0.95** (1.37kg/m)

50mm Top-Hat 1.15

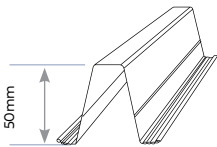

50 mm TOP HAT – 1.15
BMT: **50TH1.15** (1.63kg/m)

64mm Top-Hat 0.75

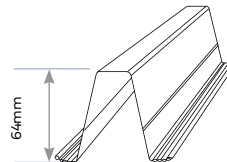

64 mm TOP HAT – 0.75
BMT: **64TH0.75** (1.26kg/m)

64mm Top-Hat 0.95

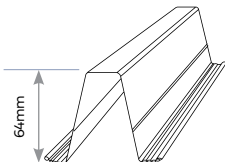

64 mm TOP HAT – 0.95
BMT: **64TH0.95** (1.58kg/m)

64mm Top-Hat 1.15

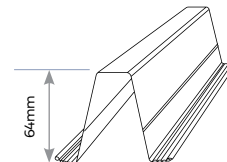

64 mm TOP HAT – 1.15
BMT: **64TH1.15** (1.91kg/m)

75mm Top-Hat 0.75

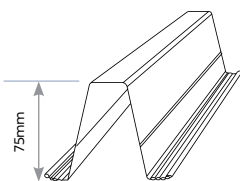

75 mm TOP HAT – 0.75
BMT: **75TH0.75** (1.41kg/m)

75mm Top-Hat 0.95

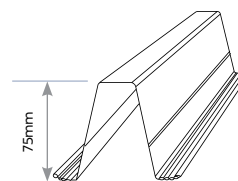

75 mm TOP HAT – 0.95
BMT: **75TH0.95** (1.77kg/m)

75mm Top-Hat 1.15

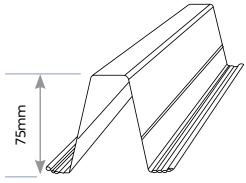

75 mm TOP HAT - 1.15
BMT: **75TH1.15** (2.14kg/m)

96mm Top-Hat 0.75

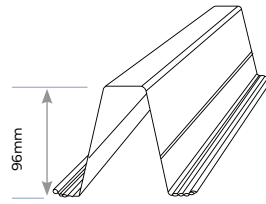

96 mm TOP HAT - 0.75
BMT: **96TH0.75** (1.74kg/m)

96mm Top-Hat Purlin 0.95

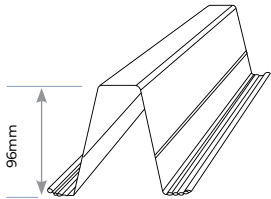

96 mm TOP HAT - 0.95
BMT: **96TH0.95** (2.19kg/m)

96mm Top-Hat 1.15

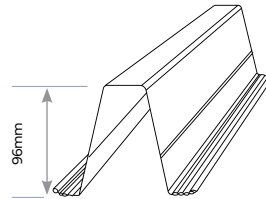

96 mm TOP HAT - 1.15
BMT: **96TH1.15** (2.65kg/m)

120mm Top-Hat 0.75

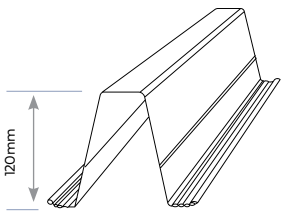

120 mm TOP HAT - 0.75
BMT: **120TH0.75** (2.17kg/m)

120mm Top-Hat 0.95

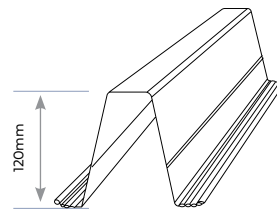

120 mm TOP HAT - 0.95
BMT: **120TH0.95** (2.73kg/m)

120mm Top-Hat 1.15

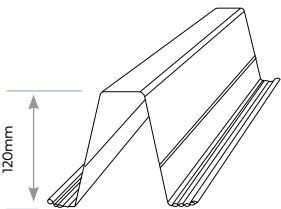

120 mm TOP HAT - 1.15
BMT: **120TH1.15** (3.30kg/m)

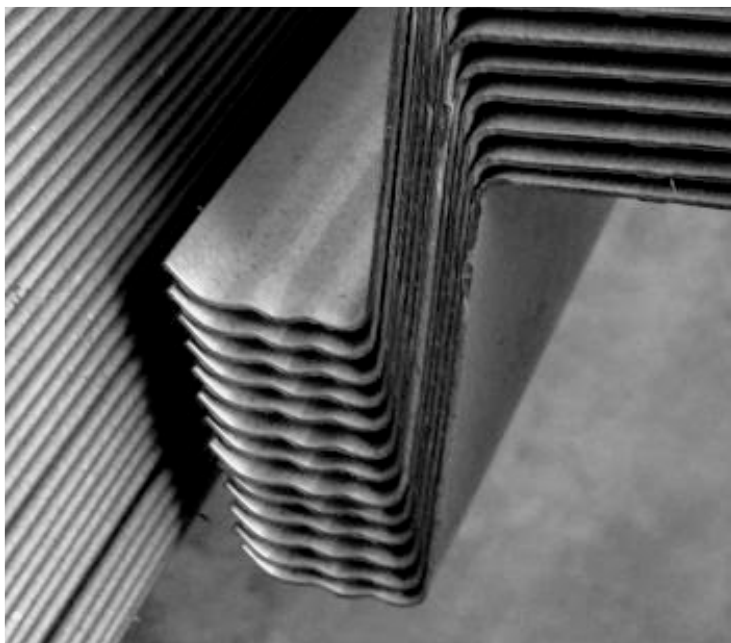

Brackets

We supply purlin brackets to complement our wide range of C & Z Purlins.

Benefits:

- We supply a quality product to make installation easy
- Our products are strong and safe
- Our production delivers precision and consistency
- We are the market leaders for quality

Angle Connector Bracket C100

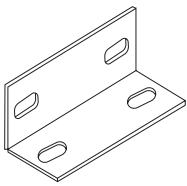

Angle Connector - C100:
MF-AC100 (0.19kg/ea)

Angle Connector Bracket C150

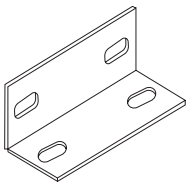

Angle Connector - C150:
MF-AC150 (0.30kg/ea)

Angle Connector Bracket C200

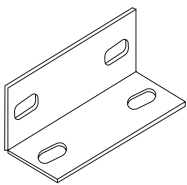

Angle Connector - C200:
MF-AC200 (0.39kg/ea)

Angle Connector Bracket C250

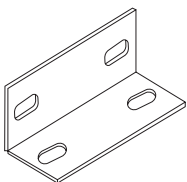

Angle Connector - C250:
MF-AC250 (0.56kg/ea)

Angle Connector Bracket C300

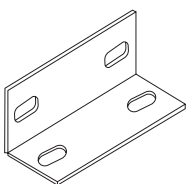

Angle Connector - C300:
MF-AC300 (0.69kg/ea)

General Purpose Bracket C100

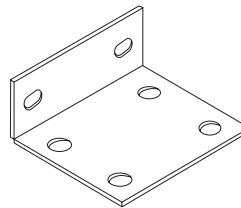

General Purpose Bracket - C100:
GPB100 (0.23kg/ea)

General Purpose Bracket C150

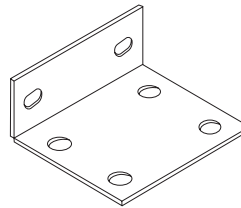

General Purpose Bracket - C150:
GPB150 (0.23kg/ea)

General Purpose Bracket C200

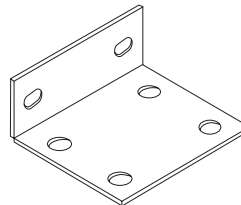

General Purpose Bracket - C200:
GPB200 (0.23kg/ea)

General Purpose Bracket C250

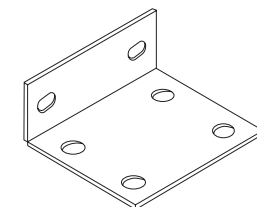

General Purpose Bracket - C250:
GPB250 (0.23kg/ea)

General Purpose Bracket C300

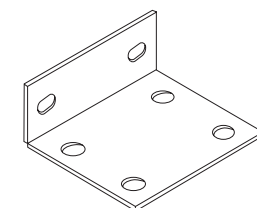

General Purpose Bracket - C300:
GPB300 (0.23kg/ea)

Purlin Bolts

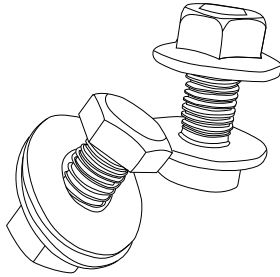

Purlin Bolts – Suitable for both C and Z Purlins

Roof Safety Mesh



Roof safety mesh provides vital fall protection for those working at heights across a range of, domestic, commercial, and industrial applications using steel or timber structures.

Roof safety mesh is an ideal support for foil underlays in exposed roof spaces and synthetic underlays.

- Must be used with enclosed building only.
- Not recommended for use with exposed roofs such as awnings as it will compromise the durability of the roof safety mesh.
- Not recommended for high moisture loading buildings.
- Should not be exposed to weather elements, such as sun, dust, rain.
- Heavy roofing machinery should not be placed on top of roof safety mesh.

Trimdek Kit or Rapid Deck

Gutter Kit

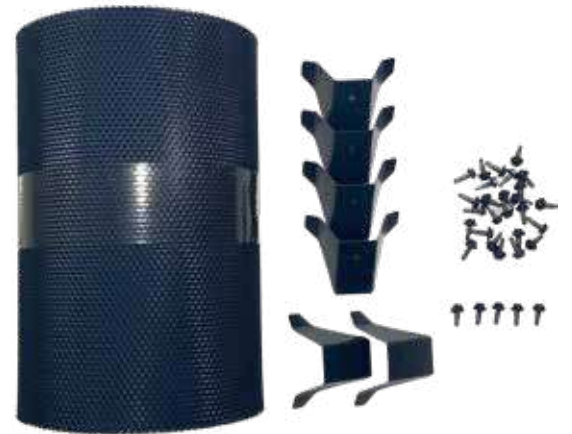

Items included

- 250mm Mesh
- Gutter Fixing Trim
- Roof Fixing Saddles
- Screws To Suit

Valley Kit



Items included

- 250mm Mesh
- Roof Fixing Saddles
- Screws To Suit

**Keep wildlife in nature,
not in your home**

Corro Roof Kits

Gutter Kit



Items included

- 250mm Mesh
- Gutter Fixing Trim
- Roof Fixing Saddles
- Screws To Suit

Valley Kit

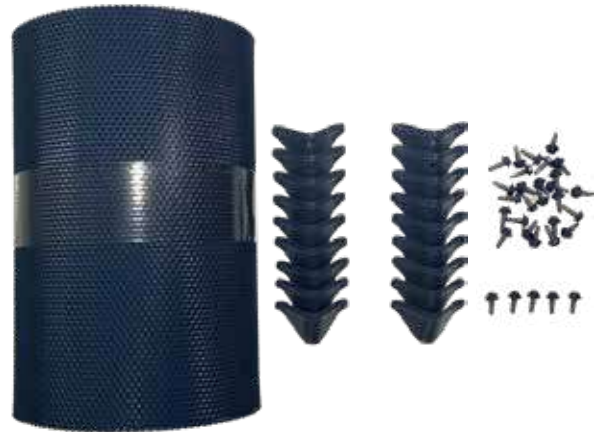

Items included

- 250mm Mesh
- Roof Fixing Saddles
- Screws To Suit

**Stop falling leaves
clogging up your gutter**

Gutter Mesh Product Range & Specifications

Premium Aluminium Gutter
Mesh (500 g/m²)

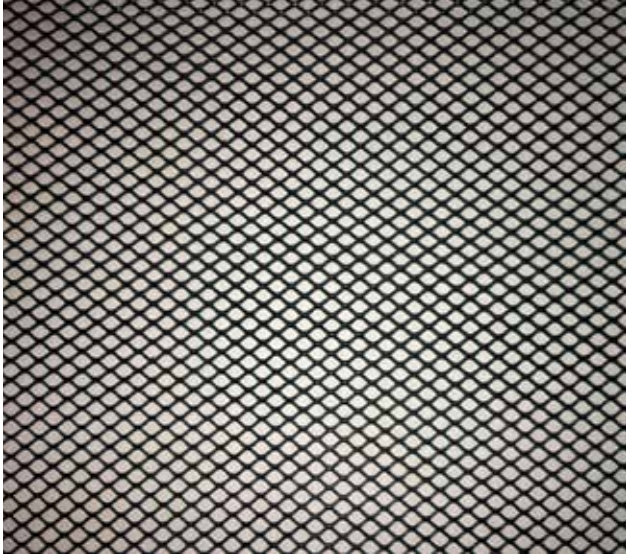

Woven Aluminium 1.9mm
Ember Guard

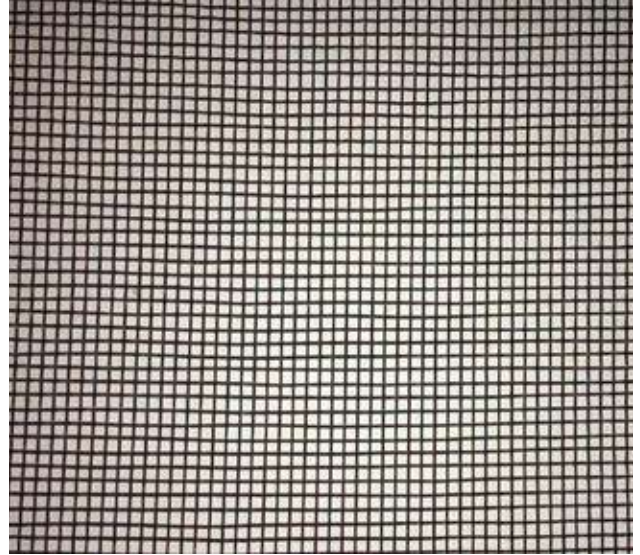

Heavy Aluminium Gutter
Mesh (700 g/m²)

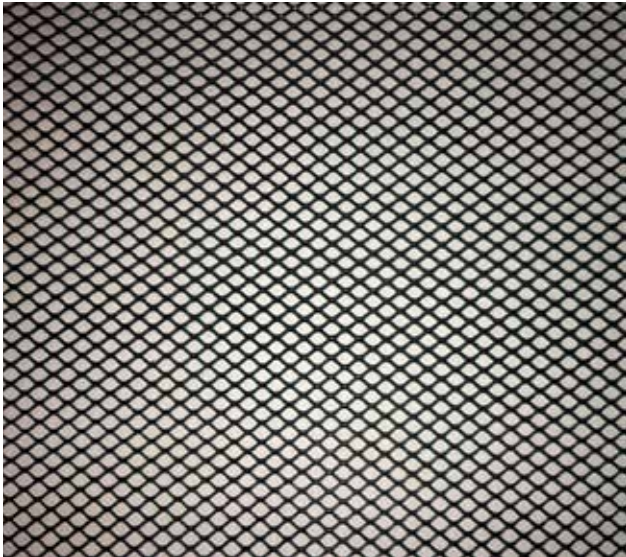

High Density Poly-Ethylene
Gutter Mesh



**Keeps nests away
from your roof**

Kliplok Kit

Klip-Lok Kit

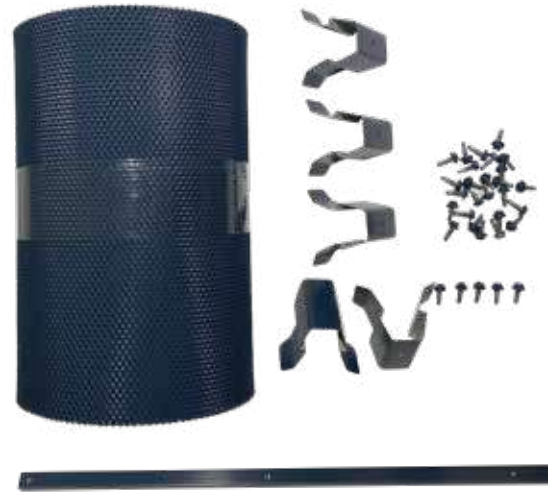

Items included

- 250mm Mesh
- Gutter Fixing Trim
- Klip-Lok Saddle Screws To Suit

Box Gutter Kit



Items included

- 250mm Mesh
- Roof Fixing Saddles
- Roof Fixing Trim
- Screws To Suit

Before



After



Tile Roof Kits

Gutter Kit



Items included

- 500mm Mesh
- Gutter Fixing Trim
- Screws to Suit

Valley Kit



Items included

- 750mm Mesh











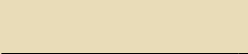





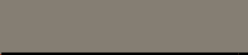

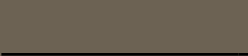
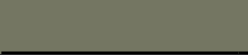
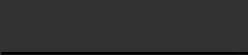

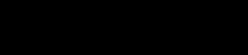

Before

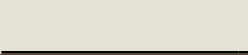

After

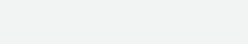

Mesh Colour Range

	Standard Aluminium 480 g/m ²	1.9mm Woven Aluminium 510 g/m ²	Heavy Duty Aluminium 700 g/m ²	HDPE (Poly) 650 g/m ²
 Basalt	✓	✓		
 Classic Cream	✓			
 Cottage Green	✓			✓
 Cove	✓			
 Dark Brown	✓			
 Deep Ocean	✓			
 Dune	✓			
 Evening Haze	✓			
 Gully	✓			
 Headland	✓			
 Ironstone	✓	✓		✓
 Jasper	✓	✓	✓	✓
 Mangrove	✓			
 Monument	✓	✓	✓	✓
 Manor Red	✓	✓	✓	✓
 Night Sky	✓			✓
 Paperbark	✓	✓		✓
 Pale Eucalypt	✓	✓	✓	
 Shale Grey	✓	✓	✓	
 Surfmist	✓	✓	✓	✓
 Terrain	✓			
 Terracotta	✓			✓
 Vincent Brown				✓
 Wallaby	✓			
 Wilderness				✓
 Windspray	✓			
 Woodland Grey	✓	✓	✓	✓
 Mill Finish	✓			

Summary of Compliance with AS 3959-2018

	Aluminium Gutter Mesh	HDPE (Poly) Gutter Mesh	1.9mm Aperture Aluminium Mesh	1.9 Aperture Stainless Steel Mesh
Base Material	Commercial Grade Aluminium	High Density Poly-Ethylene	Commercial Grade Aluminium	Marine Grade 316 Stainless Steel
Aperture	3mm x 4mm	4.0mm x 4.0mm	1.9mm x 1.9mm	1.9mm x 1.9mm

Suitable as Gutter Guard	Aluminium Gutter Mesh	HDPE (Poly) Gutter Mesh	1.9mm Aperture Aluminium Mesh	1.9 Aperture Stainless Steel Mesh
BAL-12.5	✓	✗	✓	✓
BAL-19	✓	✗	✓	✓
BAL-29	✓	✗	✓	✓
BAL-40	✓	✗	✓	✓
BAL-FZ	✓	✗	✓	✓

Suitable as Ember Guard	Aluminium Gutter Mesh	HDPE (Poly) Gutter Mesh	1.9mm Aperture Aluminium Mesh	1.9 Aperture Stainless Steel Mesh
BAL-12.5	✗	✗	✓	✓
BAL-19	✗	✗	✓	✓
BAL-29	✗	✗	✓	✓
BAL-40	✗	✗	✗	✓
BAL-FZ	✗	✗	✗	✓

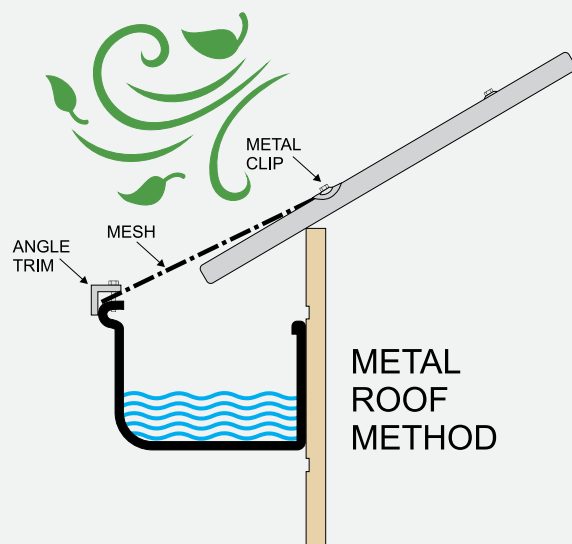
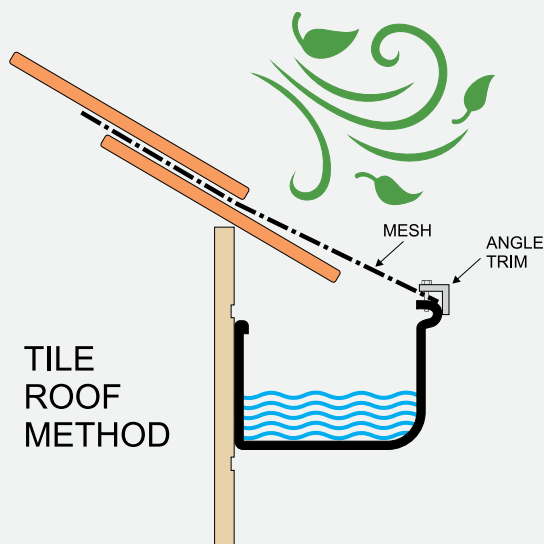

ARCHITECTURAL PRODUCTS



Discover a diverse selection of modern architectural solutions at Zammit Metal Roofing. From our renowned Rapid Seam and Rapid Clad systems to sleek aluminum battens, cladding, and decking options, we offer a comprehensive range of contemporary products to enhance your project's aesthetic appeal and functionality.



square
rib profile
exclusive to
Zammit

RAPID SEAM

Rapid Seam cladding captivates with its distinctive visual appeal, characterised by wide flat pans and an exclusive square rib design. Its clean and striking aesthetics are complemented by a seamless style, making it an exceptionally versatile cladding solution for contemporary architectural designs.

With our Rapid Seam's exclusive square ribbed profile and our Rapid Clad's sleek flat tray design, our engineered cladding offers modern crisp lines that truly stand out. Whether installed horizontally or vertically, our cladding effortlessly enhances any architectural style, infusing your project with a touch of elegance, and making a lasting impression.



Panel Length	Custom lengths to order
Standard Width	From 265mm to 465mm *special order custom widths
Material Thickness	0.55mm BMT G300 grade steel
Panel Depth (Rib)	35mm

Available in all Colorbond and Colorbond Matt colours.
* custom colours available on request.

Fast and efficient simple installation
using concealed fixing



Rapid Seam has been independently Testing by the Cyclone Testing Station which is a NATA accredited Laboratory

RAPID CLAD

Whether used in long lengths running vertically or horizontally on a structure, or in shorter lengths to create a 'block-like' effect, Rapid Clad is designed to make a bold and stylish statement. Featuring raised panels and recessed 'express' joints, this profile exudes a sleek and contemporary character, enhanced by the shadowed channels that add a pleasing level of detail.



Zammit R-Series wall and roof cladding captures the essence of contemporary design, bringing architectural inspiration to your project

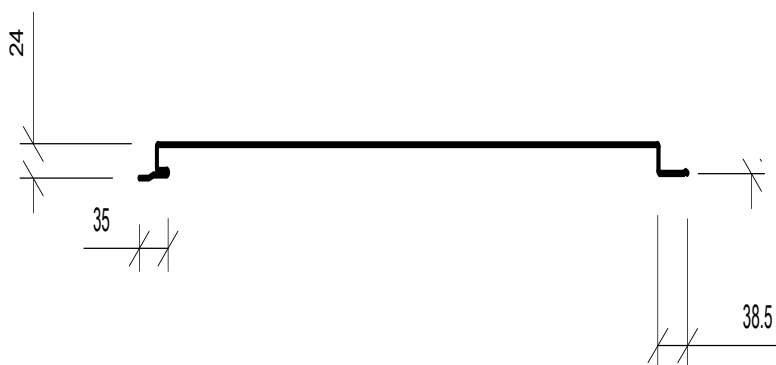

Panel Length	Custom lengths to order
Standard Width	From 285mm to 485mm *special order custom widths
Material Thickness	0.55mm BMT G300 grade steel

Available in all Colorbond and Colorbond Matt colours.
* custom colours available on request.

Fast and efficient simple installation using
concealed fixing



Rapid Clad has been independently Testing by the Cyclone Testing Station which is a NATA accredited Laboratory



Aluminium Battens, designed to elevate any architecturally inspired structure with a contemporary touch, providing a floating or free-standing aesthetic. Crafted to perfection, our aluminium battens serve a multitude of purposes, including –

- Enhancing privacy screens for balconies and pergolas
- Reinventing garage doors with a modern flair
- Transforming fences into stylish barriers
- Adding distinctive design elements to garden landscapes
- Available in a range of powder coated and wood look finishes

Based on a 2 part system. The backing is fixed to the substrate, then the batten is simply clipped on to conceal the fixings. We have over 20 different shapes and sizes that can be used with our batten extenders, spacers and backing systems.

50mm Batten Suite

50mm Bracket

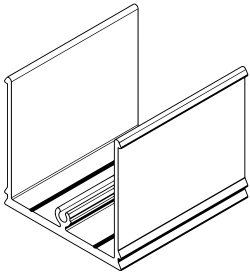

KEB5050M/SF

50 x 50mm

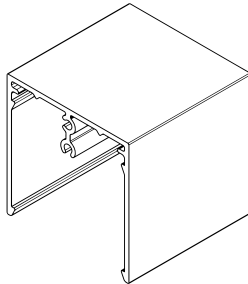

KEB5050F/SF

100 x 50mm

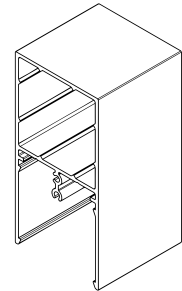

KEB10050F/SF

150 x 50mm

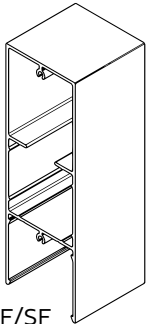

KEB15050F/SF

200 x 50mm

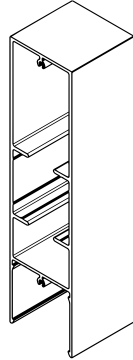

KEB20050F/SF

80 x 50mm

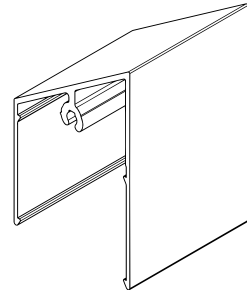

KEB8050AF

45 x 50mm

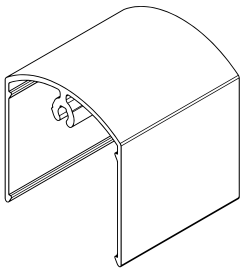

KEB5450DF

150 x 50mm

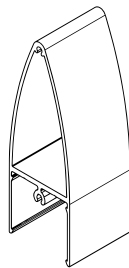

KEB15050FE

200 x 50mm

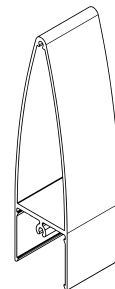

KEB20050FE

25mm Batten Suite

25mm Bracket

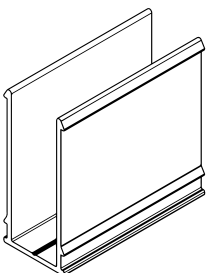

KEB5025M

50 x 25mm

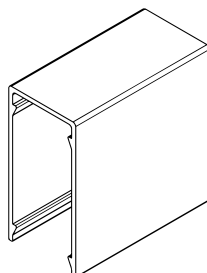

KEB502F

75 x 25mm

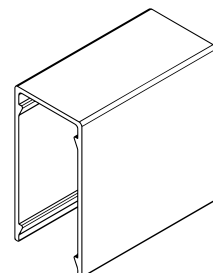

KEB7525F

25mm Batten Suite (Continued)

100 x 25mm

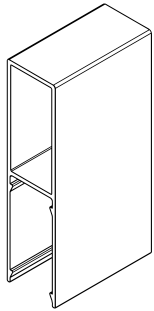

KEB10025F

150 x 25mm

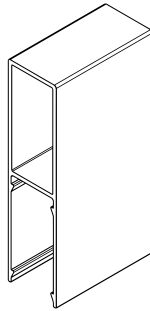

KEB15025F

Slimline Batten Suite

25 x 25mm Bracket

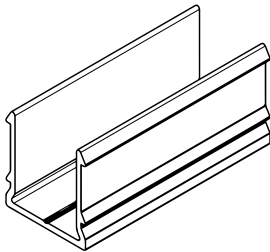

KEB2525M

25 x 25mm

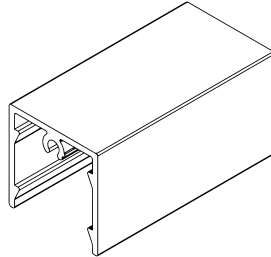

KEB2525F/SF

32 x 32mm

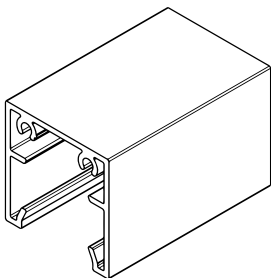

KEB3232F/SF

40 x 40mm

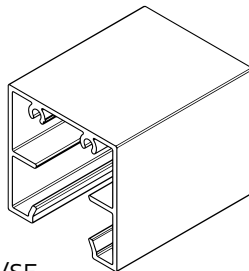

KEB4040F/SF



Wide Batten Suite

25 x 25mm Bracket

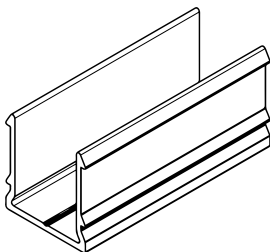

KEB2525M

25 x 50mm

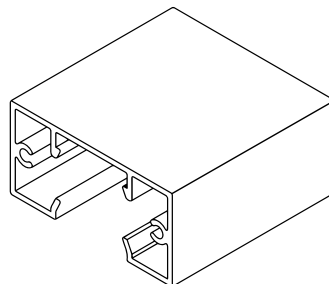

KEB2550WIDE

25 x 75mm

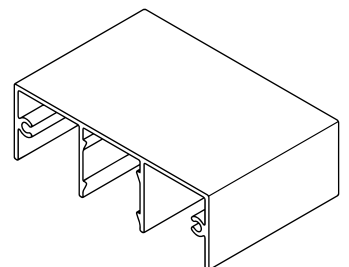

KEB2575WIDE

Wide Batten Suite (Continued)

25 x 100mm

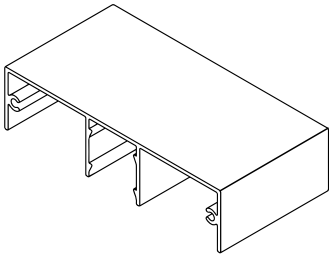

KEB25100WIDE

25 x 150mm

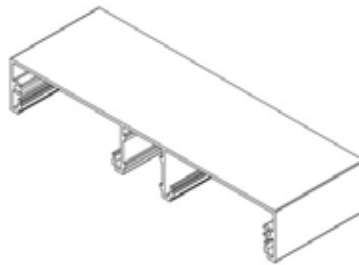

KEB25150WIDE

50mm Batten Joiners

Self Joiner

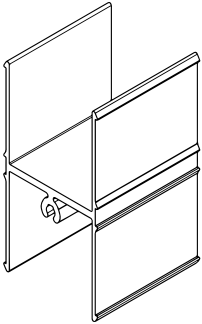

KEBJ5050

150 Joiner

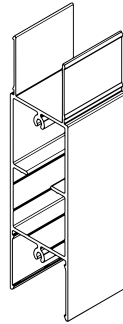

KEBJ150

45° Joiner

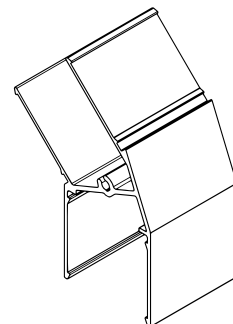

KEBJ45D

Batten Spacers (Adjustable)

25mm

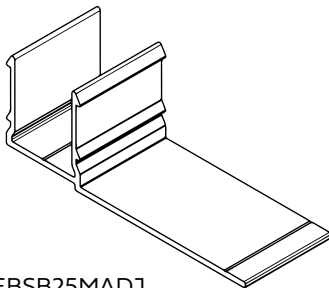

KEBSB25MADJ

50mm

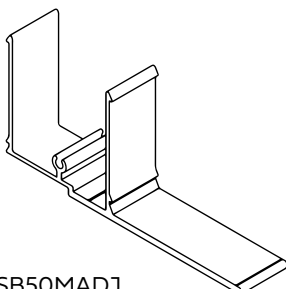

KEBSB50MADJ

Batten Mounting Plates

50mm Plate

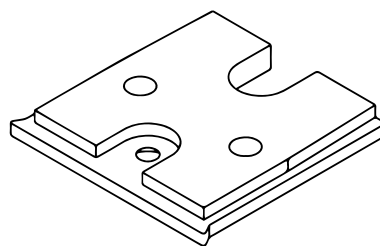

KAHMB5050-R

100 x 50mm Plate

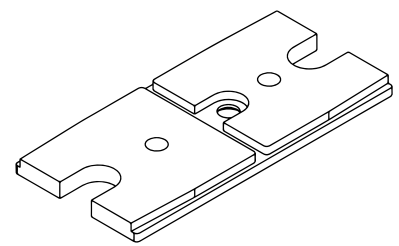

KAHMB10050-R

L Base Plate (25mm Suite)

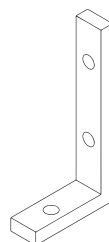

KABPBC804012-R

L Base Plate (50mm Suite)

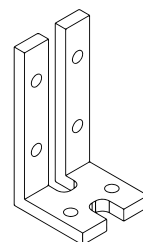

KABPBC8040-R



Elevate your home with our aluminum cladding, designed to infuse modern architectural flair while demanding minimal upkeep. Ideal for accentuating feature walls, eaves, or ceilings, its versatility extends seamlessly to both residential and commercial applications.

Available in a variety of powder coated and wood look finishes to elevate your space with style and durability.

A selection of board styles that interlock together. Trims and finishing pieces provide a clean, minimal finish.

Clip in profiles can be added to our dimensional board for a striking textured effect.

Cladding Profiles

Cladding Starter

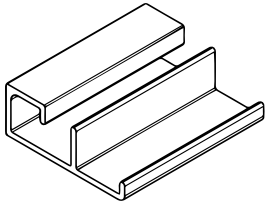

KEDSTR-SQ

100mm Board

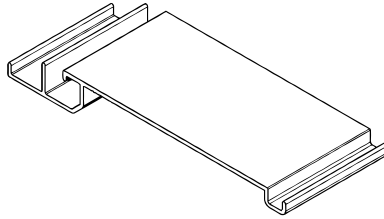

KED150

150mm Board

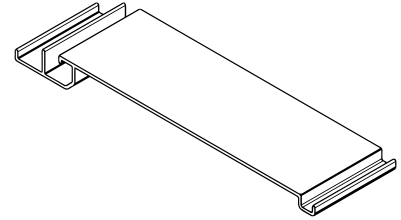

KESINFS

200mm Board

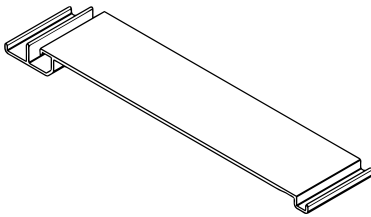

KEDSTR

150mm Shiplap Board

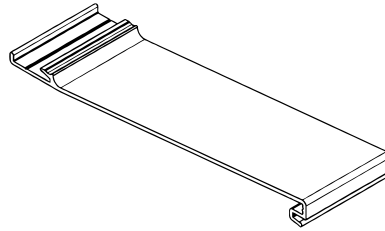

KED150

Cladding Trims

Corner Clip (Reversible)

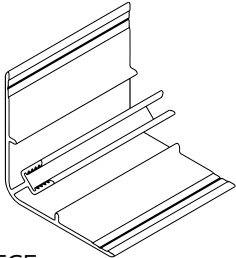

KECIECF

Corner Clip 50mm (Reversible)

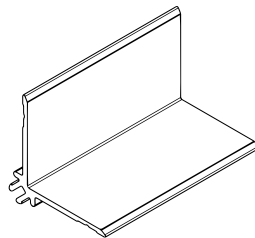

KECIECLM

Finishing Base (Reversible)

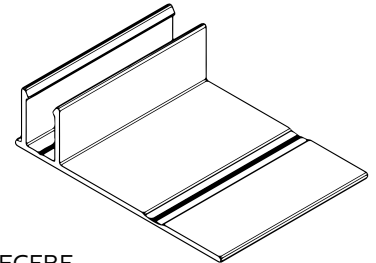

KECFBF

Finishing Top Small (Reversible)

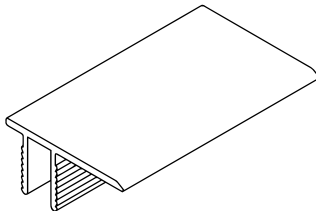

KECFTTSM

Finishing Top Large (Reversible)

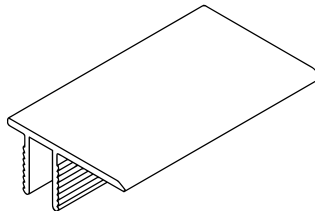

KECFTTLM

Cladding Joiner Base (Reversible)

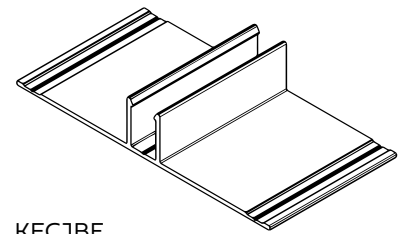

KECJBF

Cladding Joiner Top (Reversible)

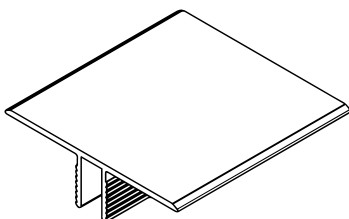

KECJTM

45mm Cladding Clip (100 Pack)

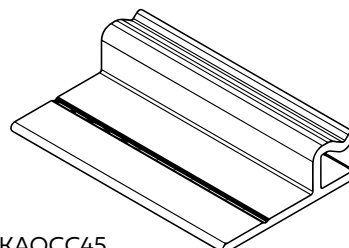

KAOCC45



Designed for lasting durability and elegance, our aluminum decking offers an ideal solution for indoor or outdoor flooring, ideal for both residential and commercial applications. Engineered from aluminum, these decks are well suited for BAL rated zones, featuring a textured surface for added traction and aesthetic appeal.

Cleverly designed decking boards that interlock and clip together. Great for balconies, roof terraces, walkways, poolsides and gardens.

Interlocking System

Decking Starter

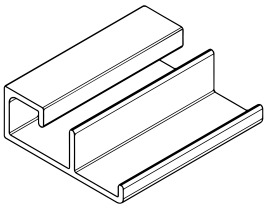

KEDSTR

150mm Decking Board

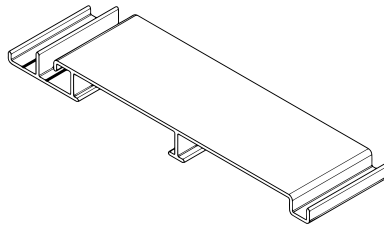

KED150

Small Infill

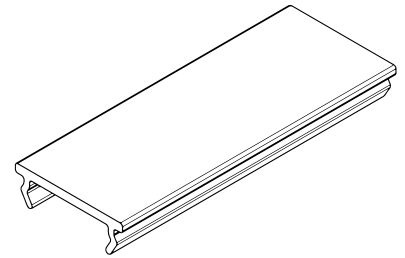

KESINFS

Concealed Finishing Angle

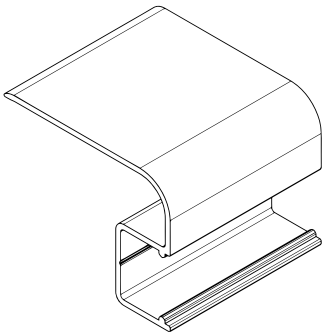

KEDFAH5050

Finishing Angle

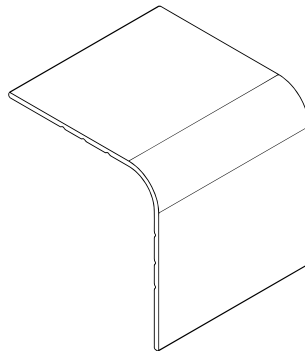

KEDFA5050

Plank System

Decking Plant 150mm

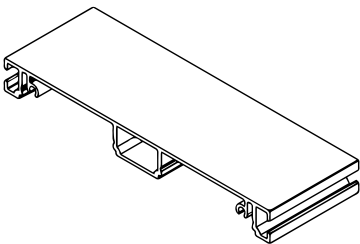

KEDP150

T Joiner

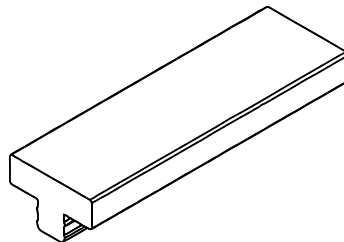

KEDPTJ

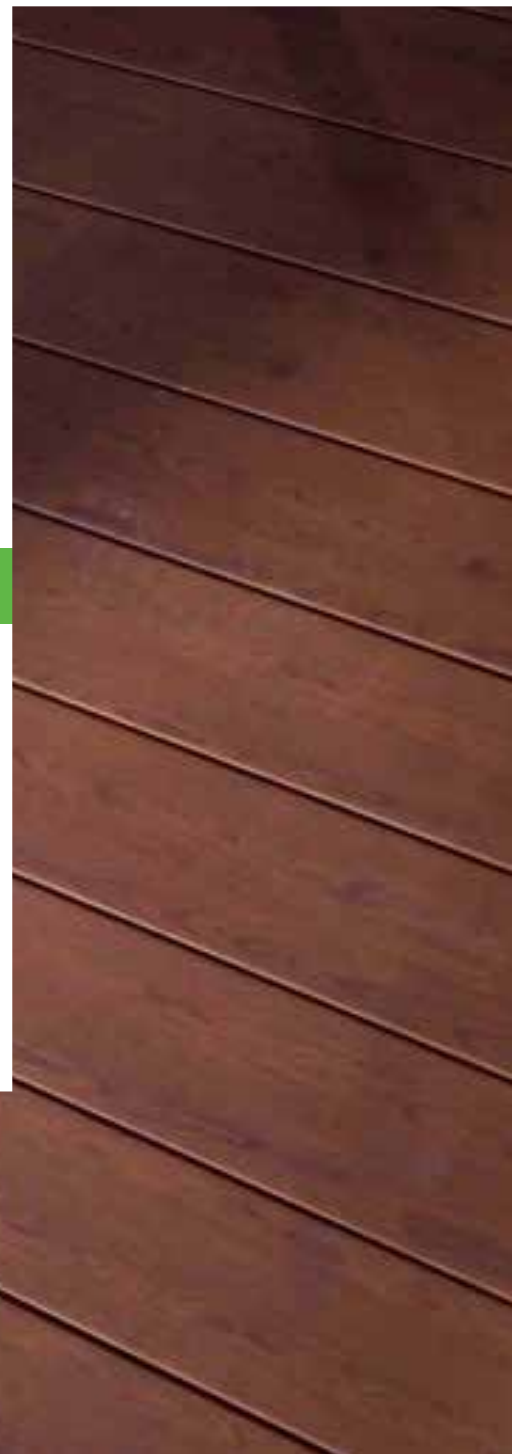



Discover limitless possibilities with our comprehensive range of Custom Trade Work manufactured to your precise requirements. Crafted with versatility in mind, our customizable products are available in various materials and colors, empowering you to achieve the ideal look for your residential or commercial application. Choose from finishes including copper, Colorbond, galvanized steel, and aluminum to bring your vision to life with precision and style.

Folded Tray

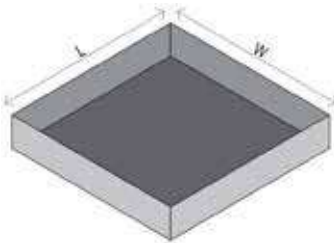

Folded Tray is fully customisable to your specifications, available in a range of materials and colours.

Enquire now for more information on our Folded Trays

Flue Caps



Flu Cap is fully customisable to your specifications, available in a range of materials and colours.

Enquire now for more information on our Flue Caps

Standard Rainwater Heads

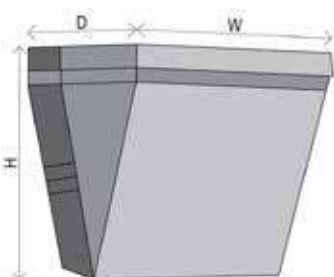

Standard Rainwater Head is fully customisable to your specifications, available in a range of materials and colours.

Enquire now for more information on our Standard Rainwater Heads

Downpipe Spreaders

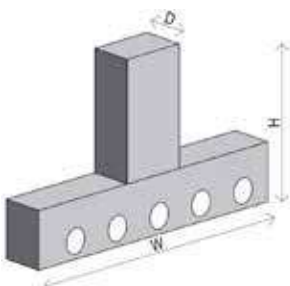

Downpipe Spreaders are fully customisable to your specifications, available in a range of materials and colours.

Enquire now for more information on our Downpipe Spreaders.

Sumps

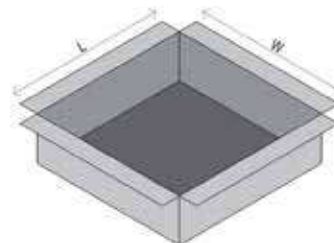

Sump is fully customisable to your specifications, available in a range of materials and colours.

Enquire now for more information on our Sumps

Louvre

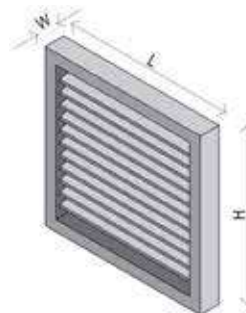

Louvre is fully customisable to your specifications, available in a range of materials and colours.

Enquire now for more information on our Louvres

Custom Rainwater Heads



Custom Rainwater Head is fully customisable to your specifications, available in a range of materials and colours.

Enquire now for more information on our Custom Rainwater Heads

Perforated Sump

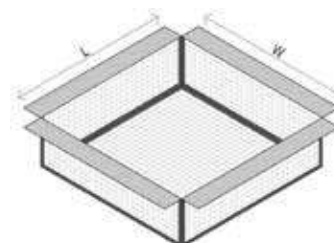

Sump is fully customisable to your specifications, available in a range of materials and colours.

Enquire now for more information on our Sumps

SKYLIGHTS



Pitched Solar-Powered Skylights

VSE

Electronically Operated



- Electrician not required to install.
- White painted interior timber frame and sash.
- Smooth profile sits lower in the roof, does not obstruct the roofline.
- Available in 10 sizes.
- Rain sensor automatically closes the skylight when rain is detected.
- High Performance double glazing, with NEAT™ outer coating: reduces cleaning frequency.
- Includes removable insect screen.
- Complete with flashing for corrugated iron or tile roofs.

VSS

Solar-Powered



VS

Manually Operated



- Electrician not required to install.
- White painted interior timber frame and sash.
- Smooth profile sits lower in the roof, does not obstruct the roofline.
- Available in 10 sizes.
- Rain sensor automatically closes the skylight when rain is detected.
- High Performance double glazing, with NEAT™ outer coating: reduces cleaning frequency.
- Includes removable insect screen.
- Complete with flashing for corrugated iron or tile roofs.

FS

Fixed (non-opening)



Sun Tunnel

TWF

Flexible



TWR

Rigid



- Choice of highly reflective rigid or flexible tunnel (350mm diameter, lengths vary – details on page 15).
- 4mm toughened external glass.
- Dual-layered ceiling diffuser – spreads light over an area of up to 9m².
- Interior diffuser with 'Edge Glow', a clear ring on the diffuser's edge.
- Outer polyurethane cappings with integrated flashings for tiled/ corrugated iron roofs.
- 'Stay clean' coating on glass exterior reduces cleaning frequency.
- Easier and quicker to install with VELUX Flexi Loc system. (TWR).

NB: For best performance VELUX recommends TWR for shafts over 1m.
 * Sun Tunnels are not suitable for roof pitches below 15°.
 ^ Bushfire testing applicable to roof pitches 18°- 60°. TWR only.

Flat Roofs

VCS

Solar-Powered



- Electrician not required to install.
- Maintenance Free – White PVC interior frame for a tough, hard wearing interior finish.
- Available in 8 sizes.
- Rain sensor automatically closes the skylight when rain is detected.
- High Performance double glazing, with NEAT™ outer coating: reduces cleaning frequency.
- Includes removable insect screen.
- Requires custom-made flashing (not supplied by VELUX).

VCM

Manually Operated



- Maintenance free – White PVC interior frame for a tough interior finish.
- Outer aluminium cappings (grey).
- Available in 7 sizes.
- High Performance double glazing as standard; with NEAT™ outer coating: reduces cleaning frequency.
- Includes removable insect screen.
- Requires custom-made flashing (not supplied by VELUX).

FCM

Fixed (non-opening)



- Unlike acrylic or polycarbonate – laminated glass will not fade nor discolour over time.
- The smooth exterior gives a lower profile on the roof.
- High Performance double glazing as standard; with NEAT™ outer coating: reduces cleaning frequency.
- Approx 99% UV Block.
- Available in 12 sizes.
- Requires custom-made flashing (not supplied by VELUX).
- Versatile positioning^{††}: most sizes can be used in portrait, landscape or even “diamond shape” orientation.

Attic Conversations

GGL

Centre pivot roof window



- A short pull on the top control bar allows filtered background ventilation even while the window remains shut.
- A second pull on the control bar allows the window to rotate for maximum ventilation – and up to 180° for cleaning the outer pane from inside the room.
- Quality white painted pine sash & frame.
- Complete with flashing for corrugated iron or tile roofs.
- Available in 5 sizes.
- Laminated double glazing as standard

GPL

Dual action roof window



- Opens in two ways: the bottom handle allows for top-hung opening; a short pull on the top control bar allows filtered background ventilation even while the window remains shut.
- A second pull on the control bar allows the window to rotate for maximum ventilation – and up to 180° for cleaning the outer pane from inside the room.
- Quality white painted pine sash & frame.
- Complete with flashing for corrugated iron or tile roofs.
- Available in 5 sizes.
- Laminated double glazing as standard.
- Insect screen available as extra.

Accessories

EDW Flashing

For metal or tile roofing



- Flashing for single skylight or roof window.
- Designed for roof pitches from 15° to 90°.
- For roofs below 15° create pitch-up and use custom made flashing (not supplied by VELUX).



Sizes

Skylights and roof windows (does not apply to FCM models) can only be installed as per orientation depicted below.

Opening Skylights (pitched roofs)



Overall frame dimension w x h mm

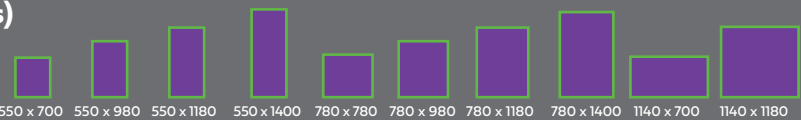

Manual Page 7

Size Code ▶

C01 C04 C06 C08 M02 M04 M06 M08 S01 S06

VS High Performance Double Glazing

✓ ✓ ✓ ✓ ✓ ✓ ✓ ✓ ✓ ✓

Package includes: Flashing for single skylight[†] in corrugated iron or tile roof (not suitable for metal profiles such as Klip-Lok, Trimdek), insect screen and operating hook. NB: Operating Rod (ZCT 300, ZOZ 032) for out-of-reach operation and winder handle (ZZZ 201 for within-reach operation) to be purchased separately.

Solar/Electric Page 5

Size Code ▶

C01 C04 C06 C08 M02 M04 M06 M08 S01 S06

VSS (Solar) High Performance double glazing

✓ ✓ ✓ ✓ ✓ ✓ ✓ ✓ ✓ ✓

VSE (Electric) High Performance double glazing

✓ ✓ ✓ ✓ - ✓ ✓ ✓ ✓ ✓

Package includes: Flashing for single skylight[†] in corrugated iron or tile roof (not suitable for metal profiles such as Klip-Lok, Trimdek), insect screen, pre installed motor, wall-mounted keypad and rain sensor, solar panel included with VSS

Blinds^{††} (VS, VSS & VSE)

Size Code

C01 C04 C06 C08 M02 M04 M06 M08 S01 S06

FSCH Solar Honeycomb Blackout[^]

NEW FSLH Pleated Translucent[^]

✓ ✓ ✓ ✓ ✓ ✓ ✓ ✓ ✓ ✓

Fixed Skylights (pitched roofs)



Overall frame dimension w x h mm

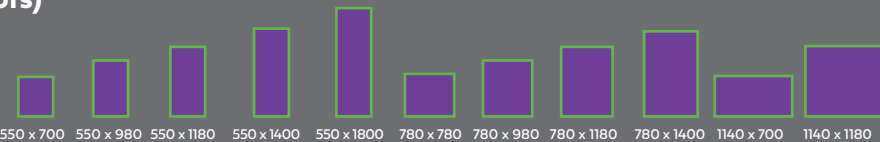

Fixed Page 9

Size Code ▶

C01 C04 C06 C08 C12 M02 M04 M06 M08 S01 S06

FS High Performance double glazing

✓ ✓ ✓ ✓ ✓ ✓ ✓ ✓ ✓ ✓

Package includes. Flashing for single skylight[†] in corrugated iron or tile roof (not suitable for metal profiles such as Klip-Lok, Trimdek).

Solar/Electric Page 5

Size Code ▶

C01 C04 C06 C08 C12 M02 M04 M06 M08 S01 S06

FSCD Solar Honeycomb Blackout[^]

✓ ✓ ✓ ✓ ✓ ✓ ✓ ✓ ✓ ✓

NEW FSLD Pleated Translucent[^]

✓ ✓ ✓ ✓ ✓ ✓ ✓ ✓ ✓ ✓

Opening Roof Windows

Recommend for within-reach situations only



(GPL 15° - 55°)

Overall frame dimension w x h mm

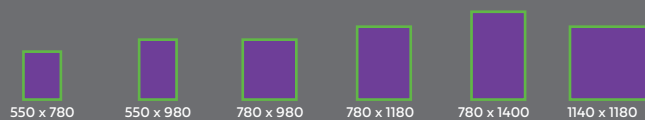

Manual Page 10

Size Code ▶

CK02 CK04 MK04 MK06 MK08 SK06

FS High Performance double glazing

✓ ✓ ✓ - ✓ ✓

GPL Dual action, Laminated double glazing

✓ ✓ ✓ ✓ ✓ ✓

Package includes: Flashing for single window[†] in corrugated iron or tile roof (not suitable for metal profiles such as Klip Lok, Trimdek).

ZIL Insect Screens (For GPL)

✓ ✓ ✓ ✓ ✓ ✓

ZIL Insect Screen is fitted to ceiling to cover plaster reveal. Suitable for within-reach applications applications only NB: side channel length to be cut to size

Blinds^{††} (GGL, GPL)

Size Code ▶

CK02 CK04 MK04 MK06 MK08 SK06

FHC Manual Honeycomb Blackout

✓ ✓ ✓ ✓ ✓ ✓

^{††} NEW VELUX blinds and flashings do not fit older VELUX products. Contact VELUX to check availability of suitable blinds and flashings.

^{*} For roofs below 15° pitch, skylights and roof windows need to be raised to 15° and custom flashed. VELUX can assist with technical advice and drawings.

[^] Wireless wall-mounted keypad supplied.

[†] For multiple sky lights/roof windows installed side by side, contact VELUX for information and pricing and combination flashing.

Delivery time (in working days)#	NSW 1-2	VIC 1-2	SA 3	ACT 1-2	QLD 2-5	NT 3-7	TAS 3-5	WA 1-2 [§]
----------------------------------	---------	---------	------	---------	---------	--------	---------	---------------------

Metropolitan areas only. Subject to order being received by VELUX before 12 EST noon. Add extra working day to delivery time for orders received by VELUX after 12 noon.

§ Subject to availability at Perth warehouse.

Price list effective 1st September 2023. All prices are supply only and include GST. Prices subject to change without notice. All prices quoted are Recommended Retail Prices (RRP) only.

Sizes

Skylights and roof windows (does not apply to FCM models) can only be installed as per orientation depicted below.

Opening Skylights (flat roofs)									
 Overall frame dimension w x h mm									
	Manual Page 7	Size Code	2222	2234	2246	3030	3046	3434	4622
VCM - High Performance double glazing	✓	✓	✓	✓	✓	✓	-	✓	
Package includes: Insect screen and operating hook. Custom flashings are required for VCM (not provided) - VELUX can assist with technical advice and drawings. NB: Operating Rod (ZCT 300, ZOZ 032) for out-of-reach operation and winder handle (ZZZ 212 for within-reach operation) to be purchased separately. NB: VCM can only be installed as per orientation depicted above.									
 Overall frame dimension w x h mm									
	Solar Page 5	Size Code	2222	2234	2246	3030	3046	3434	4622
VSS (Solar) High Performance double glazing	✓	✓	✓	✓	✓	✓	✓	✓	
Package includes: Insect screen, pre installed motor, wall-mounted keypad, rain sensor and solar panel. Custom flashings are required for VCS (not provided) - VELUX can assist with technical advice and drawings. NB: VCS can only be installed as per orientation depicted above.									
 Overall frame dimension w x h mm									
	Blinds (VCM/VCS)	Size Code	2222	2234	2246	3030	3046	3434	4622
FSCH Solar Honeycomb Blackout ^A	✓	✓	✓	✓	✓	✓	✓	✓	

Fixed Skylights (flat roofs)															
 Inner glass dimension w x h mm Overall Curb dimension w x h mm															
	Fixed	Size Code	1430	2222	2230	2234	2246	2270	3030	3046	3055	3434	3446	4646	3072
FCM	✓	✓	✓	✓	✓	✓	✓	✓	✓	✓	✓	✓	✓	✓	✓
NB: FCM can be positioned in portrait or landscape (FCM 2270/3072/4672 not recommended for landscape orientation). Custom flashings are required for FCM (not provided) - VELUX can assist with technical advice and drawings. Contact VELUX for information on blinds for FCM.															

Sun Tunnels		 Tunnel diameter 350mm 460 x 460
TWF OK14	Sun Tunnel with flexible shaft - 2200mm long, 350mm diameter	
TWR OK14	Sun Tunnel with rigid shaft - 1650mm long, 350mm diameter	
ZTR OK14	Rigid extension - 1240mm (NOT suitable for TWF)	
Package complete with integrated flashing for tiled or corrugated iron roofs (not suitable for metal profiles such as Klip-Lok, Trimdeck), tunnel and ceiling diffuser. Sun Tunnels are not suitable for roof pitches below 15°		

Electric and Rod Controls		
ZZZ 201	Winder handle (white) to operate VS openable skylights within reach	
ZZZ 212	Winder handle (white) to operate VCM openable skylights within reach	
ZOZ 032	Short rod control (60cm) to operate within reach, manual openable skylights	
ZCT 300	Extendable rod control to operate manual openable skylights 145cm - 285cm length	
KLI 310	Wall Mounted keypad for use with electric/solar Skylights and Blinds	
KIX 300	VELUX ACTIVE starter kit - includes 1 x internet gateway, 1 x climate sensor, 1 x departure switch	
KLA 300	Additional climate sensors recommended if multiple rooms contain opening skylights	
KLF 200	Interface Unit. Connect to building management systems, sensors and switches. Individual control of 5 products (or groups), up to 200 products in total	

Delivery time (in working days)#	NSW 1-2	VIC 1-2	SA 3	ACT 1-2	QLD 2-5	NT 3-7	TAS 3-5	WA 1-2 [§]
----------------------------------	---------	---------	------	---------	---------	--------	---------	---------------------

Metropolitan areas only. Subject to order being received by VELUX before 12 EST noon. Add extra working day to delivery time for orders received by VELUX after 12 EST noon.

§ Subject to availability at Perth warehouse.

Price list effective 1st September 2023. All prices are supply only and include GST. Prices subject to change without notice. All prices quoted are Recommended Retail Prices (RRP) only.

Ace Quad



FLOW RATE:

Volume in 1m length 1.5 litres / second.
6.2 litres measured to overflow holes.
Available Slotted or Unslotted



ACE QUAD
ACCESSORIES

Steel Fascia



STEEL FASCIA
ACCESSORIES

Fascia Cover



FASCIA COVER
ACCESSORIES



External 90° Angle



Internal 90° Angle



External 45° Angle



Internal 45° Angle



External Bracket



Right & Left Hand Return Stop End



Stop End



Concealed Suspension Bracket



Overstrap Bracket



Concealed Bracket



Timber Suspension Clip



Quad Overflow Nozzle



Metal Fascia Suspension Clip



10mm and 5mm Ace Spacer Clip



90° & 45° Internal Angles



Internal Straight Joiner



Barge Moulds



90° Barge Rafter Bracket



External 45° Angle



External 90° Angle



Erection Bracket



Barge Apex Cover



Metal Fascia Suspension Clip



Barge Rafter Bracket



45° Hip Rafter Bracket



Standard Rafter Bracket

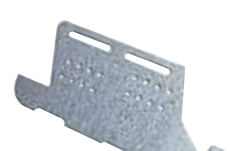

Steel Frame Bracket



90° & 45° Internal Angles



External 90° Angle



Internal Straight Joiner



External 45° Angle

Half Round



FLOW RATE:

Volume in 1m length with overflow holes 1.5 litres / second.

2.5 litres / second without overflow holes.

6.48 litres measured to overflow holes.

7.16 litres measured to back of gutter.



HALF ROUND
ACCESSORIES

Roundline



FLOW RATE:

Volume in 1m length with overflow holes 1.5 litres / second.

2.5 litres / second without overflow holes.

6.32 litres measured to overflow holes.

7 litres measured to back of gutter.



ROUNDLINE
ACCESSORIES

Nu-Line



FLOW RATE:

Volume in 1m length 5 litres / second.

12.6 litres measured to overflow holes.



NU-LINE
ACCESSORIES



External 90° Angle



Internal 90° Angle



External 45° Angle



Internal 45° Angle



Stop End



Half Round Overflow Nozzle 90mm
100x50mm/100x75mm



External Bracket
(colour screws supplied)



Angle Cutting Template



100 x 50mm Nozzle



90mm Round Nozzle



100 x 75mm Nozzle



External 90° Angle



Internal 90° Angle



External 45° Angle



Internal 45° Angle



Concealed Suspension Bracket



Overstrap Bracket



Timber Fascia Suspension Clip



Stop End



Metal Fascia Suspension Clip



90mm Round Nozzle



100mm x 50mm Nozzle



100mm x 75mm Nozzle



Round Overflow Nozzle 90mm
100x50mm/100x75mm



Angle Cutting Template



External 90° Angle



Internal 90° Angle



Straight Joiner



No 1 External Bracket

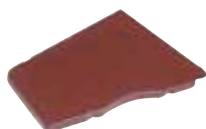

Stop End

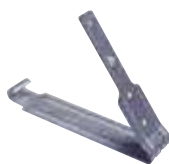

Concealed Bracket



Bead & Rafter Bracket



Metal Roof Bracket

Mini-Line



FLOW RATE:

Volume in 1m length 2.5 litres / second.
7.3 litres measured to overflow holes.



MINI-LINE
ACCESSORIES

90mm Round Downpipe



FLOW RATE:

90mm Round Downpipe
Volume in 1.8m length 11.44 litres.
Flow Capacity of 90mm 4.2 litres per second.



90MM ROUND DOWNPIPE
ACCESSORIES

Rainwater Heads & Leafguards



Leafguard Painted 25% Gloss & Plain

Slate Grey, Mountain Blue, Ebony.

Ace Leaf Diverter® & Rainwater Heads.

All Colours & Plain.

RAINWATER HEADS & LEAFGUARDS
ACCESSORIES



External 90° Angle



Internal 90° Angle



External 45° Angle



Internal 45° Angle



External Brackets (Painted)



Overstrap Bracket

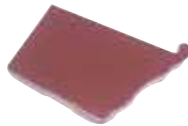

Stop End

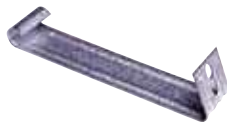

Concealed Bracket



Metal Fascia Suspension Clip



Timber Suspension Clip



Mini-Line Erection Bracket



90mm Joiner



Astragal



90mm Nozzle



82° Offset



45° Offset



17° Offset

NB: We recommend that plain fittings be painted prior to installation.



Leafguard

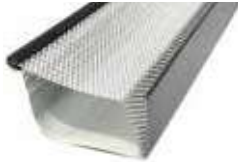

Rainwater Head



Rainwater Head



100 x 50mm Ace Leaf Diverter®



90mm Ace Leaf Diverter®



100 x 75mm Ace Leaf Diverter®

Square-Line



FLOW RATE:

Volume in 1m length 5 litres / second.
12.6 litres measured to overflow holes
Available slotted or unslotted



Concealed Overstrap



Stop End



Concealed Suspension Bracket



Leafguard

N.B. Leafguard requires some degree of maintenance after installation

**Rollform Downpipe
100mm x 50mm**



FLOW RATE:

100 x 50mm
Volume in 1.8m length 9 litres.
Flow Capacity 3.5 litres per second.

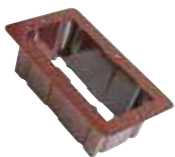

100 x 50mm Nozzle



100 x 50mm Rollform Astragal



100 x 50mm Rollform Offset Adjustable



100 x 50mm Offset

NB: We recommend that plain fittings be painted prior to installation.

**Rollform Downpipe
100mm x 75mm**



FLOW RATE:

100 x 75mm
Volume in 1.8m length 13.5 litres.
Flow Capacity 4.4 litres per second.



100 x 75mm Rollform Astragal



100 x 75mm Nozzle



100 x 75mm Offset



100 x 75mm Rollform Offset

NB: We recommend that plain fittings be painted prior to installation.

Durakote Colour Range



Gull Grey



Brown
Roof Sheets not
available in this colour



Jasmin Brown



Mist Green



Caulfield Green



Birch



Ebony



Iron Grey

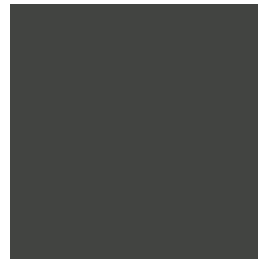

Slate Grey



Wallaroo



Gulf

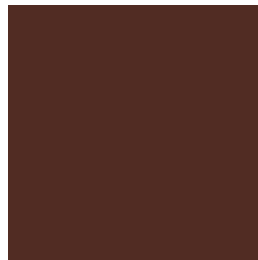

Heritage Red

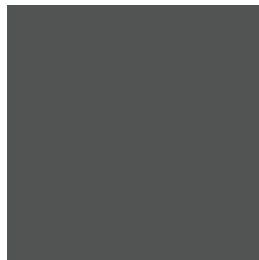

Basal

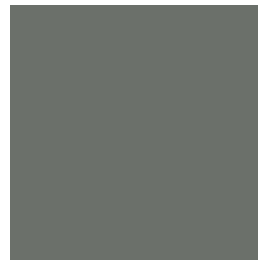

Armour Grey



Monolith



Merino



Smooth Cream



Dusk



Off White

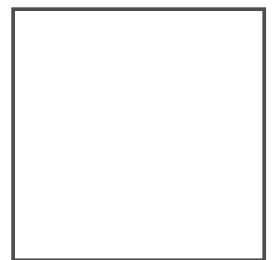

White



Mountain Blue



Zammit Metal Roofing Products stocks a wide range of PVC pipes, downpipes, junctions, nozzles, pipe adaptors, pipe bends and pipe sockets.

80mm PVC Downpipe



Colours Available in

- White
- Paperbark
- Classic Cream
- Slate Grey
- Monument

Pipe 80mm to 90mm Adaptor



Colours Available in

- White
- Paperbark
- Classic Cream
- Slate Grey
- Monument

Junction



Colours Available in

- White
- Paperbark
- Classic Cream
- Slate Grey
- Monument

PVC Pipe 92 Deg Bend



Colours Available in

- White
- Paperbark
- Classic Cream
- Slate Grey
- Monument

PVC Pipe 112 Deg Bend



Colours Available in

- White
- Paperbark
- Classic Cream
- Slate Grey
- Monument

PVC Pipe Socket



Colours Available in

- White
- Paperbark
- Classic Cream
- Slate Grey
- Monument

Nozzle



Colours Available in

- White
- Paperbark
- Classic Cream
- Slate Grey
- Monument

Astragals



Colours Available in

- White
- Paperbark
- Classic Cream
- Slate Grey
- Monument

ZMR PERGOLA RANGE

A modern outdoor patio featuring a pergola with a dark, slatted roof and blue LED lighting. The patio is furnished with a dining table and chairs, a lounge sofa, and a coffee table. The walls are made of grey brick, and there are large glass doors leading to an indoor space. The floor is made of light-colored wood.

If you're looking to add a touch of luxury and elegance to your outdoor space, a Zammit pergola is the perfect addition. Our pergolas are made with engineered aluminium, fully customisable, available in a range of colours and come in three beautiful designs – louvered roof, insulated roof, and rafted roof. A Zammit pergola will transform any outdoor space into an oasis.

Discover our collection of Pergolas & Awnings in the ranges.

The Belvedere – Louvered Roof Pergola



If you're looking for a way to improve your outdoor living space, a louvered roof pergola is the perfect solution! Our Belvedere pergola is not only stylish and sophisticated, but it's also perfect for entertaining guests all year long, no matter what the weather is like. As our pergolas are completely customisable, it is suited to either small or large gardens, next to pools, and even on decks or patios. Plus, you have complete control over the amount of sun or shade that is allowed into the space. So, whether you want to enjoy a sunny day outdoors or escape the heat of the midday sun, a louvered roof pergola has you covered!

The Belvedere is

- Fully customisable
- Available in powder coated steel or engineered aluminium
- Available in custom colours to suit any design
- Full remote control louvered roof system



The Retreat – Insulated Roof Pergola



Looking for a stylish and functional addition to your backyard space? Look no further than The Retreat – Insulated Roof Pergola. This custom designed pergola is perfect for any backyard and is ideal for entertaining all year round. With its chic design and insulated roof, this pergola will give your entertaining the WOW factor!

The Retreat is

- Fully customisable
- Available in powder coated steel or engineered aluminium
- Available in custom colours to suit any design
- Insulated Roof panels – multiple options available



The Atrium



Exposed Rafted Roof Pergola

Our Rafted Roof Pergola is the perfect way to enjoy the outdoors in style! This custom-made pergola is perfect for adding an extra outdoor living area, or for use beside the pool and will provide you with years of enjoyment.

The Atrium is

- Fully customisable
- Available in powder coated steel or engineered aluminium
- Available in custom colours to suit any design
- Engineered aluminium exposed Rafted Roof beams





Zammit Metal Roofing Products stocks a wide range of engineered aluminium beams, posts, slats, brackets & accessories to suit. Available in mill finish or powder coated in a range of colours.

Ideal for pergola's awning, privacy screens, bearers & joists & other applications.

Engineered Aluminium Powder Coated Beam



Available Sizes

150mm x 50mm	170mm x 50mm	-
--------------	--------------	---

Engineered Aluminium Beam - Mill Finish



Available Sizes

150mm x 50mm	170mm x 50mm	-
--------------	--------------	---

Engineered Aluminium Powder Coated Post



Available Sizes

90mm x 90mm	150mm x 150mm
250mm x 50mm	235mm x 50mm

Engineered Aluminium Post - Mill Finish



Available Sizes

90mm x 90mm	150mm x 150mm
250mm x 50mm	235mm x 50mm

Rounded End Cap

Suitable for Aluminium



Available Sizes

105mm x 50mm	170mm x 50mm	-
--------------	--------------	---

Z Bracket

Powder coated available to colour specification



Available Sizes

105mm x 50mm | 170mm x 50mm | -

Notched Post Connector



Available Sizes

90mm x 90mm | 150mm x 150mm | -

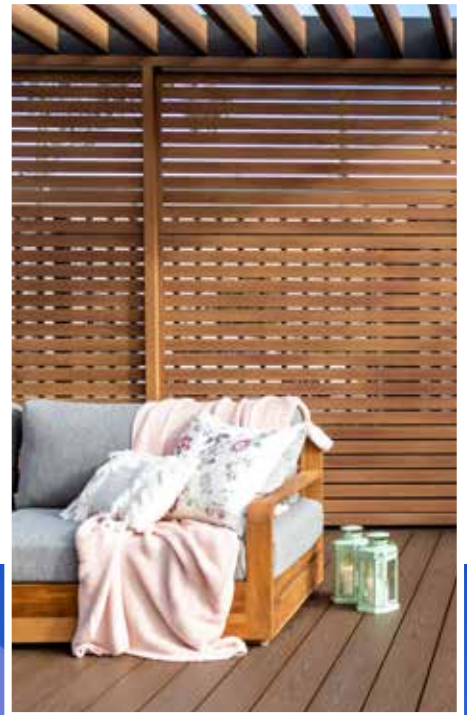

Privacy Screen

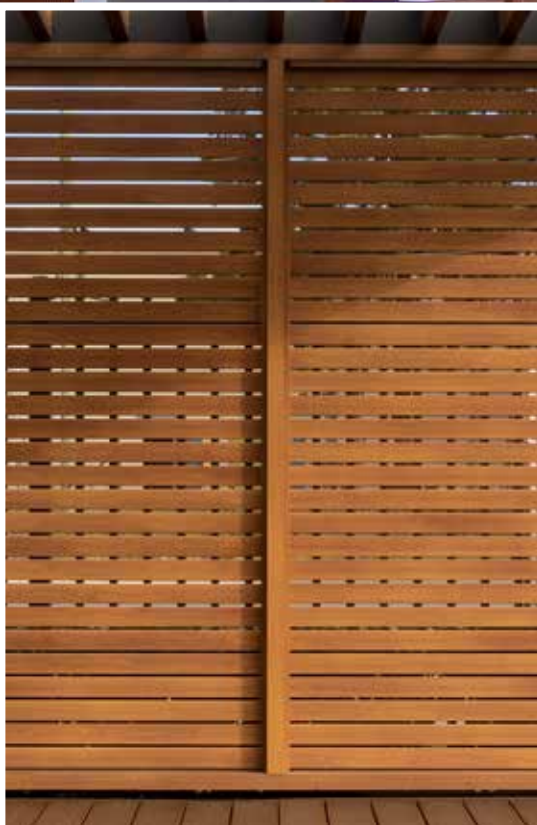

Zammit Metal Roofing Products stocks aluminium slats ideal for privacy screens, available in mill finish or custom powder coating.
Stock length 6.5 meters
65mm x 16mm – 1.4mm thickness

Available accessories

- **20mm x 20mm slat side channel
- Stock length 6.5 meters
- available in mill finish or powder coated finish
- **20mm slat spacer



Zammit Metal Roofing Products stocks a wide range of steel beams, posts, brackets, and accessories to suit. Available in galvanised or powder coated in a range of colours.

Ideal for pergola's & awning's, bearers & joists, & other applications.

Powder Coated Steel Beam



Powder coated available to colour specification

Available Sizes

100mm x 50mm | 150mm x 50mm | 200mm x 50mm

Galvanised Steel Beam



Available Sizes

100mm x 50mm | 150mm x 50mm | 200mm x 50mm

Powder Coated Steel Post



Available Sizes

50mm x 50mm | 60mm x 60mm | 90mm x 90mm

Galvanised Steel Post



Available Sizes

50mm x 50mm | 60mm x 60mm | 90mm x 90mm

Powder Coated Steel Post Cap



Available Sizes

90mm x 90mm Domed Galvabond | 50mm x 50mm Black Domed Plastic | 60mm x 60mm Black Flat Plastic

Plastic Post Cap



Available Sizes

100mm x 50mm

3mm Galvanised Rafter Bracket



Internal Post Base



Available Sizes

50mm x 50mm	60mm x 60mm	90mm x 90mm
-------------	-------------	-------------

Collar Tie Bracket



Available Sizes

100mm x 50mm 15° Deg & 22.5° Deg	150mm x 50mm 15° Deg & 22.5°
-------------------------------------	---------------------------------

Corner Bracket



Available Sizes

100mm x 50mm	150mm x 50mm	200mm x 50mm
--------------	--------------	--------------

End Cap Bracket



Available Sizes

100mm x 50mm	150mm x 50mm	200mm x 50mm
--------------	--------------	--------------

Suspension Bracket



Available Sizes

100mm x 50mm	150mm x 50mm	200mm x 50mm
--------------	--------------	--------------

Pitching Bracket



Available Sizes

100mm x 50mm 22.5° Deg	150mm x 50mm 22.5° Deg	200mm x 50mm 22.5° Deg
100mm x 50mm 15° Deg	150mm x 50mm 15° Deg	200mm x 50mm 15° Deg

Apex Bracket



Available Sizes

100mm x 50mm 22.5° Deg	150mm x 50mm 22.5° Deg	200mm x 50mm 22.5° Deg
100mm x 50mm 15° Deg	150mm x 50mm 15° Deg	200mm x 50mm 15° Deg

Mitre End Cap



Available Sizes

100mm x 50mm	150mm x 50mm	200mm x 50mm
--------------	--------------	--------------

45° Deg End Cap



Available Sizes

100mm x 50mm	150mm x 50mm	200mm x 50mm
--------------	--------------	--------------



Zammit Metal Roofing Fascia Gutter offers a modern, clean look along with the strength advantages of a stiffened back for excellent performance. Our gutters are machined pressed to guarantee a straight length and a large capacity for water drainage. The high front profile conceals the edge of the roofline for a neat, finished look.

Our fascia gutter range is available in a variety of COLORBOND® steel colours and finishes, making them perfect for carports, awnings, and compatible with most of our pergola range.

- COLORBOND® .055 pressed
- 8 meter max length
- Only available unslotted

Accessories sold separately.

Zammit Fascia Gutter



Zammit Gutter Stud Channel



Zammit Gutter Stiffener Gal 1.2



Z Bracket



Available Sizes

150mm x 50mm | 170mm x 50mm



Aluminium Beams - Mill Finish

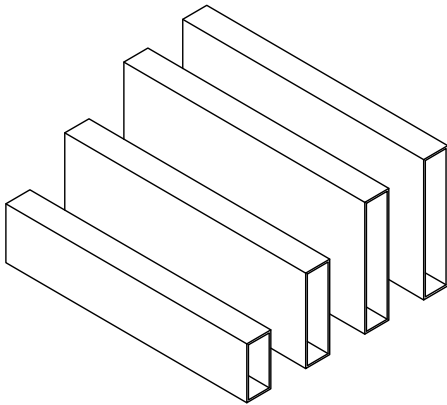

Steel Posts

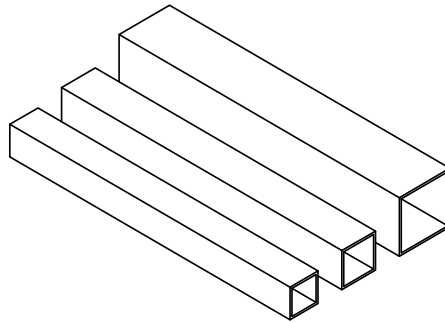

Galvanised Steel Beams

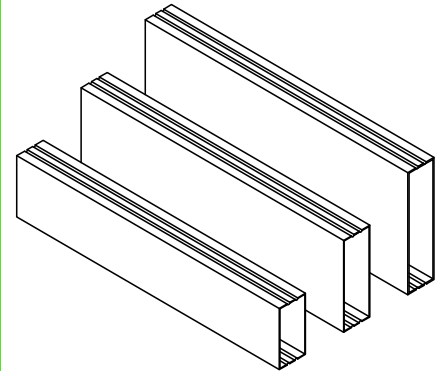

Aluminium Mill

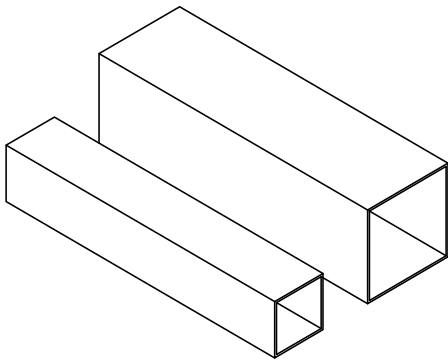

Spacemaker

Only 1 degree pitch & up to 11.4m trafficable free span

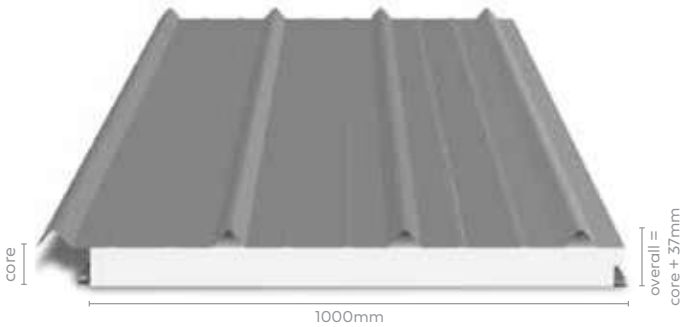

Key Features & Benefits

- Minimum roof pitch only 1° - lowest pitch available
- Our longest trafficable **unsupported span** of up to **11.4m** means less unsightly support beams
- **Maximum panel length of 15.0m**
- Lightweight and easy to install
- Wiring services run through core duct
- Custom 37mm high trapezoidal profile
- Fire retardant EPS insulated core dramatically reduces radiant heat transfer, mould and condensation
- **Fire flashings** available to suit up to BAL 40
- **LED downlights** and **ceiling fan mounting plates** available
- Solar panel installation engineering
- **Skylight strips** now available in kits
- Side eave overhang up to 450mm based on full width panel. **Cantilever** distance up to **2.85m**
- Ceiling surface available in **Smooth, Micraline, Luxline** or **Embossed** in colours as shown.

Spacemaker Span Table

Wind Class in accordance with AS4055-2012	Panel Size	Maximum Single Span		
		Fully Enclosed Room	One Side Open	Two/Three Sides Open
N1 (W28N)	50mm	7039	6533	7039
	75mm	8557	7716	8557
	100mm	9367	8508	9367
	125mm	10508	9475	10508
	150mm	11407	10285	11407
N2 (W33N)	50mm	6275	5690	6275
	75mm	7123	6459	7123
	100mm	7853	7121	7853
	125mm	8746	7931	8746
N3 (W41N)	150mm	9494	8609	9494
	50mm	4939	4487	4939
	75mm	5606	5093	5606
N3 (W41N)	100mm	6181	5616	6181
	125mm	6883	6254	6883
	150mm	7473	6789	7473
Other wind classes	N4 (W50N) - C1 (W41C) - C2 (W50C) - C3 (W60C)			

In accordance with Wind actions: AS/NZS 1170.2:2011 - Clause 5.3, 5.4 and D4; AS 4055-2012. Imposed load on roof: AS/NZS 1170.1:2002 - Clause 3.5

Cantilever ability of the panel is 25% of the maximum allowable span, provided there is double the desired cantilever as a backspan. Maximum side eave achievable is 450mm, based on using a full width panel. Fixing Details: Fixed to support member with 14g self drilling screws at every crest. Typically 3 screws to each panel, at each support. Request engineering specs for more information.

Spacemaker Specifications

Width	Length (Cut to Order)	Min. Roof Pitch
1000mm Cover	Min: 1800mm Max: 15000mm	1°

Spacemaker only available with Left Hand Lap and 60mm gutter cutback configuration

Roof Colour Range (Lower skin 0.5mm G300 Steel)



* Equivalent colour names are trademarks of BlueScope Steel Limited and used only for comparison. Colour swatches are provided as an indication of colour only and may not be an actual representation of colour. We recommend checking your chosen colour against an actual sample of the product before purchasing.
• Limited Warranty applies to these dark colours.

Ceiling Colour & Finish Options (Lower skin 0.5mm G300 Steel)

Ceiling Colours



Ceiling Finishes

(NB: Images darkened to show textures)

Ceiling Finishes (NB: Images darkened to show textures)



Corrolink S 1000

Only 1 degree pitch & up to 11.4m trafficable free span

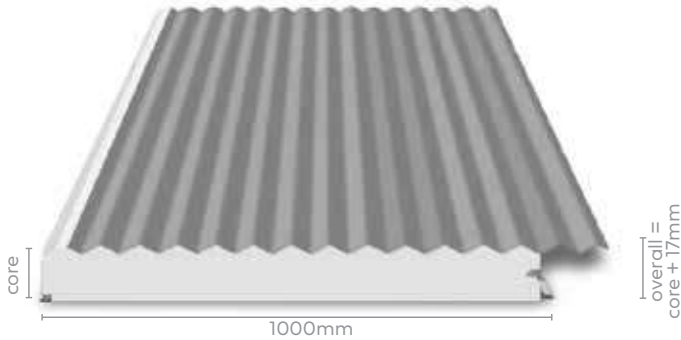

Key Features & Benefits

- Minimum roof pitch only 3°
- Long trafficable **unsupported span** of up to **10.0m** means less unsightly support beams
- Lightweight and easy to install
- Wiring services run through core ducts
- Fire retardant EPS insulated core dramatically reduces radiant heat transfer, mould and condensation
- **Fire flashings** available to suit up to BAL 40
- **LED downlights** and **ceiling fan mounting plates** available
- Solar panel installation engineering
- Side eave overhang up to 450mm based on full width panel. **Cantilever** distance up to **2.89m**
- Panels customised to your cutback and lapping specs
- **Skylight strips** now available in kits
- Ceiling surface available in **Smooth, Micraline, Luxline** or **Embossed** in colours as shown.

Corrolink-S (1000) Span Table				
Wind Class in accordance with AS4055-2012	Panel Size	Maximum Single Span		
		Fully Enclosed Room	One Side Open	Two/Three Sides Open
N1 (W28N)	50mm	7515	6776	7515
	75mm	8958	8077	8958
	100mm	9343	8425	9343
	125mm	9742	8785	9742
	150mm	10000 (10618*)	9574	10000 (10618*)
	180mm	10000 (11579*)	10000 (10441*)	10000 (11579*)
N2 (W33N)	50mm	6255	5672	6255
	75mm	7456	6761	7456
	100mm	7777	7052	7777
	125mm	8109	7353	8109
	150mm	8832	8014	8832
	180mm	9638	8739	9638
N3 (W41N)	50mm	4923	4473	4923
	75mm	5870	5335	5870
	100mm	6121	5561	6121
	125mm	6400	5810	6400
	150mm	6956	6320	6956
	180mm	7585	6892	7585
Other wind classes	N4 (W50N) - C1 (W41C) - C2 (W50C) - C3 (W60C)			

In accordance with Wind actions: AS/NZS 1170.2:2011 - Clause 5.3, 5.4 and D4;
Imposed load on roof: AS/NZS 1170.1:2002 - Clause 3.5

*Maximum manufactured ceiling length = 10000mm.
Maximum engineered spans used for cantilever lengths; cantilever ability of the panel is 25% of the maximum allowable span, provided there is double the desired cantilever as a backspan.
Maximum side eave achievable is 450mm, based on using a full width panel. Fixing Details: Fixed to support member with 14g self drilling screws at every alternate crest. Typically 7 screws to each panel, at each support. Request engineering specs for more information.

Spacemaker Specifications		
Width	Length (Cut to Order)	Min. Roof Pitch
1000mm Cover	Min: 1800mm Max: 15000mm	1°
Spacemaker only available with Left Hand Lap and 60mm gutter cutback configuration		

Roof Colour Range (Lower skin 0.5mm G300 Steel)

 Off White (*Surfmist)	 Smooth Cream (*Classic Cream)	 Merino (*Paperbark)	 Dusk (*Evening Haze) ^Min. 50LM
 Gulf (*Gully) ^Min. 50LM	 Basal (*Basalt)	 Jasmin Brown (*Jasper)	 Slate Grey (*Woodland Grey)
 Gull Grey (*Shale Grey)	 Birch Grey (*Dune)	 Armour Grey (*Windspray)	 Walloo (*Wallaby) ^Min. 50LM
 Mist Green (*Pale Eucalypt)	 Heritage Red (*Manor Red)	 Unizinc (Zincalume®) ^Min. 50LM	 Caulfield Green (*Cottage Green) ^Min. 50LM • Ltd Warranty
 Mountain Blue (*Deep Ocean) ^Min. 50LM • Ltd Warranty	 Iron Grey (*Ironstone) • Limited Warranty	 Monolith (*Monument) • Limited Warranty	 Ebony (*Night Sky) ^Min. 50LM • Ltd Warranty

* Equivalent colour names are trademarks of BlueScope Steel Limited and used only for comparison. Colour swatches are provided as an indication of colour only and may not be an actual representation of colour.
We recommend checking your chosen colour against an actual sample of the product before purchasing.
• Limited Warranty applies to these dark colours.

Ceiling Colour & Finish Options (Lower skin 0.5mm G300 Steel)

Ceiling Colours

 Pearl White • Smooth • Embossed • Micraline • Luxline	 Cream • Smooth • Micraline • Luxline	 Merino • Smooth • Micraline • Luxline
--	--	---

ALL finishes are for illustration purposes only. For true representation please request a colour swatch.

MagnaFlow™ Corrosion Resistant Top & Ceiling Options

 Off White ^	 Armour Grey ^	 Off White ^ • Smooth • Micraline • Luxline
------------------------	--------------------------	--

^ Additional linear metre fees apply for MagnaFlow™ colours.
• Only available in MagnaFlow™ top skin/ceiling skin combinations as shown to left.

Ceiling Finishes (NB: Images darkened to show textures)

 Smooth	 Embossed	 Micraline (Now available on Spacemaker)	 Luxline (New planked look finish)	 Luxline Golden Oak ^ Planked timber effect finish
-------------------	---------------------	---	---	---

^ Additional linear metre fees apply for woodgrain timber effect finishes.

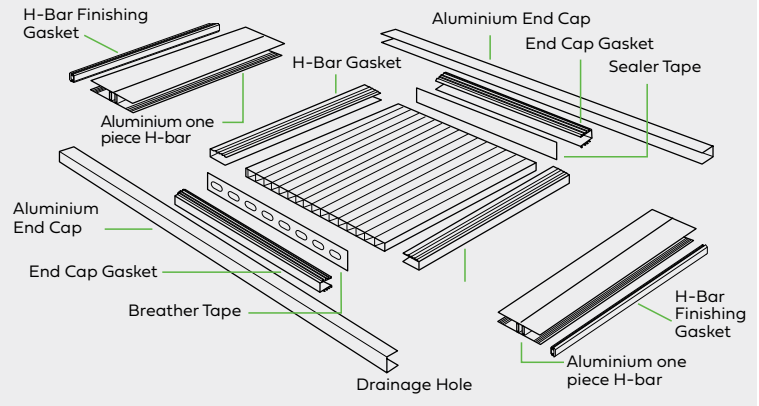

Standard Colours

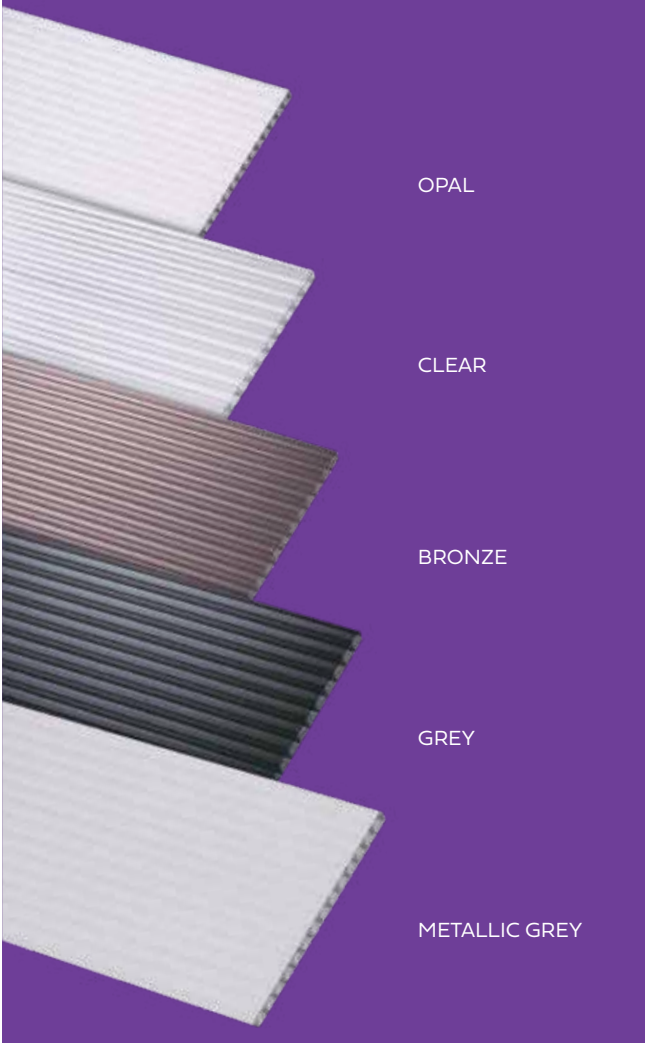

Sheet Colours, Sizes and Spanning

A MINIMUM OF 5 DEGREE FALL IS REQUIRED

Colours 10mm - Clear, Opal, Bronze, Grey, Metallic Grey
16mm - Clear, Opal

Widths 700mm, 1050mm

Lengths 2.0m, 2.5m, 3.0m, 3.5m, 4.0m, 4.5m, 5.0m, 5.5m, 6.0m, 7.0m

Other sizes and colours may be available. Please confirm availability before ordering.

	700mm		1050mm	
	Rafter	Purlins	Rafter	Purlins
10mm	720mm	not required	1050mm	not required
16mm	720mm	not required	1050mm	not required

Above figures based on 1.5kPa.

For installation in high winds, please contact Zammit Roofing.

Sheet mass

10mm	1700 gsm	16mm	2700 gsm
------	----------	------	----------

Available Sheet Structure

Ampelite recommend using standard gauge 10 mm twinwall sheeting for most residential and smaller commercial applications. The 16 mm gauge is often specified for larger projects.

A range of other gauges to suit almost any project are available subject to order quantities. Please consult your nearest Zammit Roofing office for current stock lead time.

10mm twin wall Sheet structure

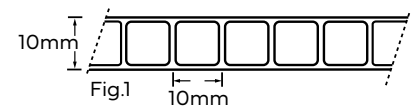

16mm twin wall Sheet structure

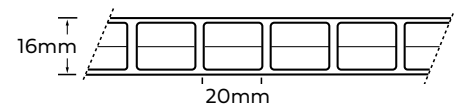

Light and Heat Transmission

10mm Twinwall

U-Value: 3.0W/m2k	LT	SHGC
Clear	81%	0.85
Opal	64%	0.71
Bronze	35%	0.55
Grey	20%	0.50
Metallic	16%	0.29

16mm Tripplewall

U-Value: 2.27 W/m2K	LT	SHGC
Clear	74%	0.78
Opal	63%	0.69

Comparison to Glass

	10mm Multiwall	10mm Standard Clear Glass
Thermal U-value	3.0 W/m2k	5.7 W/m2k
Impact Resistance	250	1
UV Resistance	99.90%	0%
Weight	1.7kg/m2	25kg/m2
Sound Insulation	19db	28db

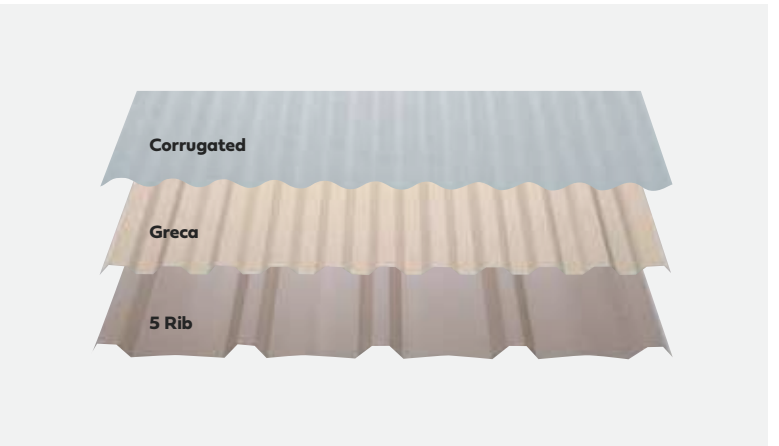

Level 1

<p>CORRUGATED - Colours Clear, Opal, Grey, Light Bronze, Smooth Cream, Dark Tint.</p>	<p>GRECA - Colours Clear, Opal, Grey, Light Bronze, Smooth Cream, Dark Tint.</p>	<p>5 RIB - Colours Clear, Opal, Grey, Light Bronze, Dark Tint. See colour chart, shade factors, light and heat</p>	<p>transmission. Sheet cover 760mm. See table of sheet lengths.</p>
--	---	---	--

Level One – SolaSafe Range Key: 0 = Full Light 10 = Full Shade

The most widely used Solasafe polycarbonate sheet. Six colours with varying light and heat transmission.

<p>CLEAR Shade Factor 1 Light Transmission 91% Heat Transmission 85.2%</p>	<p>LT. BRONZE Shade Factor 3 Light Transmission 36% Heat Transmission 60.6%</p>	<p>GREY Shade Factor 5 Light Transmission 26% Heat Transmission 50%</p>
<p>OPAL Shade Factor 7 Light Transmission 55% Heat Transmission 40.2%</p>	<p>DARK TINT Shade Factor 7 Light Transmission 17% Heat Transmission 38.9%</p>	<p>SMOOTH CREAM Shade Factor 7 Light Transmission 44% Heat Transmission 35.2%</p>

Temperatures in direct sunlight are greater than the temperatures given in weather reports. The shade factors shown provide an indication of the heat absorbed or reflected by the Solasafe sheet.

Level Two – SolaFrost Range Key: 0 = Full Light 10 = Full Shade

The SolaFrost range. Low transmitted heat, softer light, more comfort.

<p>CLEAR Shade Factor 2 Light Transmission 91% Heat Transmission 85.2%</p>	<p>GREY Shade Factor 7 Light Transmission 91% Heat Transmission 85.2%</p>
--	---

Ampelite SolaFrost will significantly reduce the amount of direct sunlight and glare when compared with standard polycarbonate sheeting. This in turn greatly enhances comfort of your outdoor area.

Unlike Level 1 Standard polycarbonate transparent sheeting, Zammit Roofing SolaFrost is a translucent (diffused) polycarbonate product.

This greatly enhances outdoor comfort.

- Translucency = Heat and glare reductions.
- Transparency = Some heat and glare.
- Matt texture helps eliminate expansion noise unlike standard polycarbonate sheeting.

Level Three – HR1 Range Key: 0 = Full Light 10 = Full Shade

Solasafe HR1 Heat reducing sheeting. Especially suitable in hot climates.

<p>PEARL ICE Shade Factor 6 Light Transmission 87% Heat Transmission 85.2%</p>	<p>SILVER MIST Shade Factor 7 Light Transmission 27% Heat Transmission 49.87%</p>
--	---

Light transmission of all colours and grades is determined in accordance with AS/NZS 42574. The colour representations of Solasafe polycarbonate above are as accurate as the nature of the material and commercial photographic and printing processes allow. It is probable that colour tints may vary between those shown in this brochure.

Level Three Solasafe HR1 has a metallic finish that reflects the heat and gives soft diffused light.

5 RIB



PROFILE NAME:		5-RIB
OTHER NAMES:		APCLAD COWELL DECK HANDEK M-CLAD MONOCLAD ROOFDEK STEELCLAD 762 TRIMCLAD TRIMDEK
COVER:	760	
PITCH:	190	
WIDTH:	820	

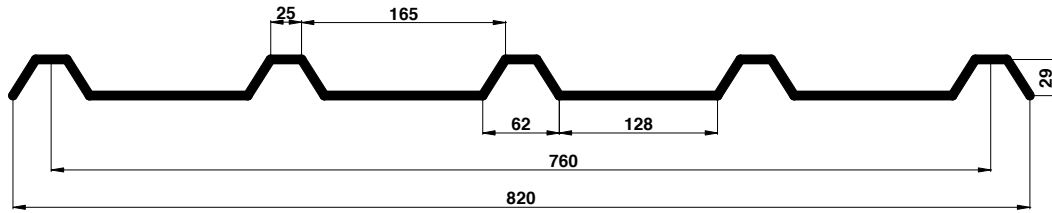

CORRUGATED



PROFILE NAME:		CORRUGATED
OTHER NAMES:		CORODEK COWELL CUSTOM ORB JET DECK MARATHON ROLEX ROMA
COVER:	760	
PITCH:	76	
NOTES	890	
WIDTH	Double cover COG Dual Roof: 2, 5, 8, 11	

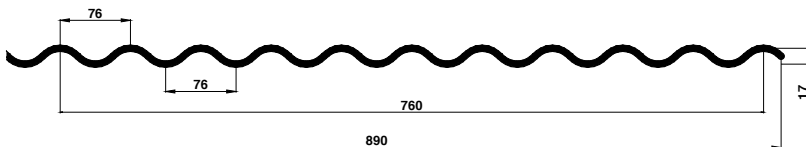

KLIPIK 700



PROFILE NAME:		KLIPIK 700
OTHER NAMES:		
COVER:	700	
PITCH:	233	
NOTES	760	
WIDTH	MANUFACTURER: BHP	

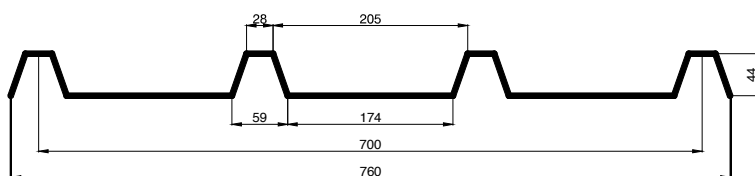

ACCESSORIES

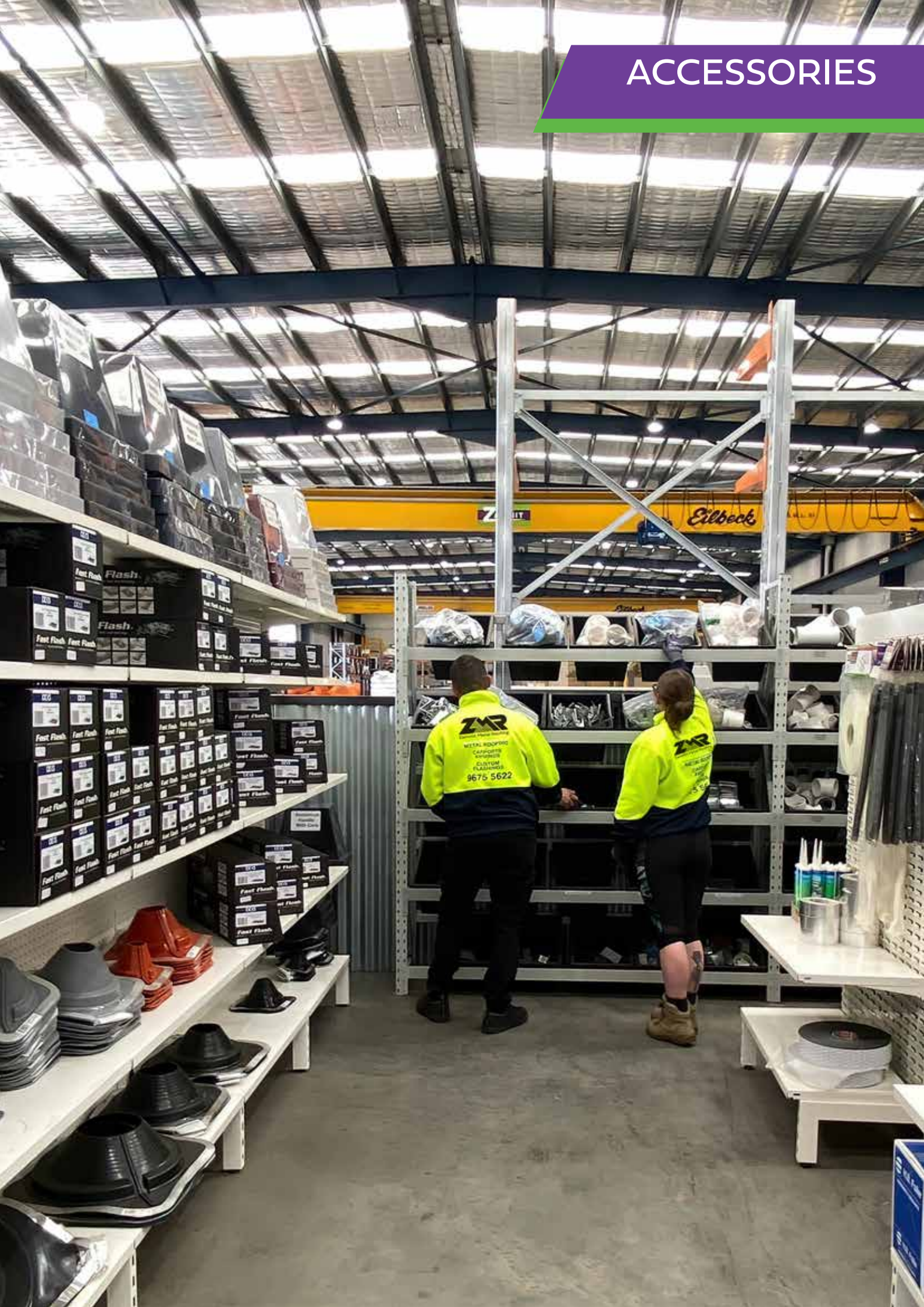

ZMR
METAL ROOFING
CARPENTRY
CONCRETE
CUSTOM
FLASHINGS
9675 5622

ZMR
METAL ROOFING
CONCRETE
CUSTOM
FLASHINGS
9675 5622

Insulation



Fasteners & Screws



Dektites



Infill Strips - Deck Top



Sold separately, allow 1 foam Infill Strip per roof sheet

Infill Strips - Deck Bottom



Sold separately, allow 1 foam Infill Strip per roof sheet

Infill Strips - Corrie



Sold separately, allow 1 foam Infill Strip per roof sheet

Infill Strips - Greca 180°



Sold separately, allow 1 foam Infill Strip per roof sheet

Infill Strips - Spandek 180°



Sold separately, allow 1 foam Infill Strip per roof sheet

Infill Strips - Kliplok 180°



Sold separately, allow 1 foam Infill Strip per roof sheet

Infill Strips - Versiclad 180°



Sold separately, allow 1 foam Infill Strip per roof sheet

**Presstite Multi-Purpose
Joint Filler 50mm x 25mm**



Sold per pack (5) in 2 metre lengths (10 lineal metres)

Fast Flash



Measuring Tape



Whirly Bird



Instant Water Proofing



Pop Rivet Gun



Nail Holder



Nail Plugs



1/8 Pop Rivets



150g Touch-Up Paint Spray Cans



Silicone Sealer & Silicone Gun



Pro Snips - Left, Right & Straight Cut



An extensive range of metal roofing accessories, including:

- Fasteners & Screws
- Whirlybirds
- Decktides
- Fastflash
- Hand Tools
- Rainwater Accessories
- Touch Up Paint

Explore our range to find the perfect solutions for your roofing needs.



Colorbond®



KNOTWOOD™
Stunning Aluminium

MILLFORM AUSTRALIA

KARBON



SPANMOR

BREMICK™

WARATAH™
FIRST - BECAUSE IT LASTS.

BOXSPAN™

Versiclad



VELUX®



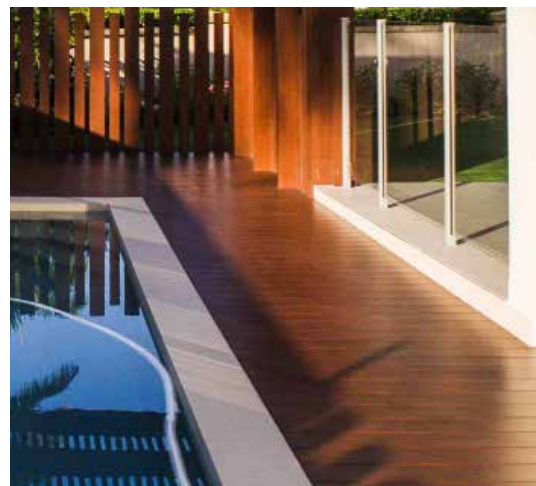

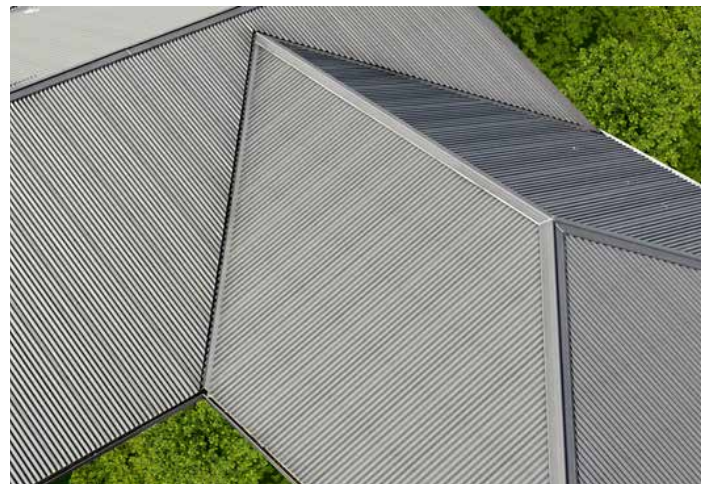

Zammit Metal Roofing



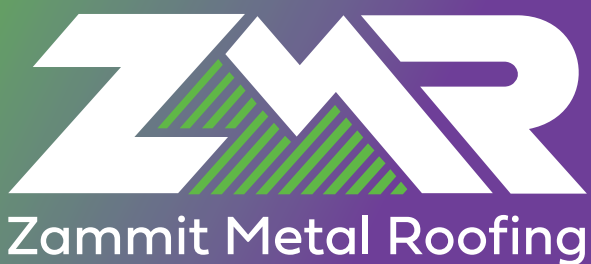

82 Glendenning Road,
Glendenning, NSW 2761, Australia

(02) 9675 5622
sales@zammitroofing.com.au
www.zammitroofing.com.au

f zammitroofing

ig zammitroofing